

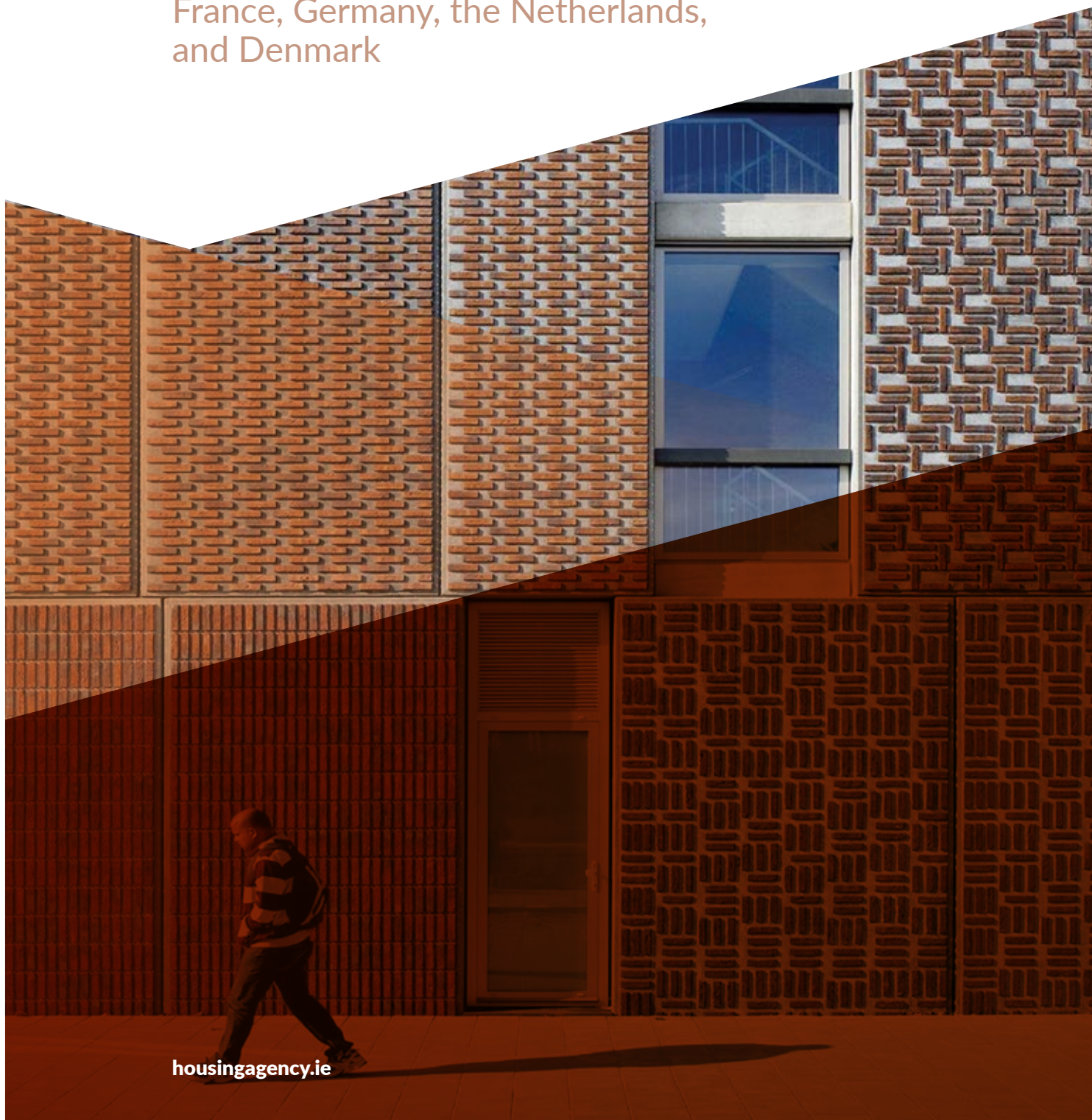

An Ghníomhaireacht  
Tithíochta  
The Housing Agency

# Social, affordable, and co-operative housing in Europe

Case studies from Switzerland, Austria, France, Germany, the Netherlands, and Denmark



**October 2020**

**Disclaimer**

This report is solely for educational purposes and is provided for information and personal, non-commercial use only.

The ownership and intellectual property rights for attributed text and images remains with the source website and relevant third parties.

All reasonable precautions have been taken by the Housing Agency to verify the reliability of the material in this publication and to provide appropriate citations.

No liability whatsoever is accepted to any person or body arising out of any reliance on the contents of this document.

**ISBN: 978-1-903848-70-8**

# Contents

<b>Introduction</b>	<b>3</b>
<hr/>	
<b>1 / Elements of good housing design – points from case studies</b>	<b>4</b>
<hr/>	
<b>2 / Switzerland</b>	<b>10</b>
Social, co-operative, and affordable housing in Switzerland	11
Case study 1: Hagmannareal affordable housing, Winterthur	13
Case study 2: Affordable housing, Zurich	17
Case study 3: Seven small apartments, Aarau	20
Case study 4: Affordable apartment building, Zurich	23
Case study 5: Kalkbreite Complex, co-operative housing, Zurich	26
Case study 6: Bochardon co-operative housing, Lausanne	29
Case study 7: Brüggliäcker housing estate, Zurich	33
Case study 8: Green City plot B3, Zurich	36
<hr/>	
<b>3 / Austria</b>	<b>41</b>
Social, co-operative, and affordable housing in Austria	42
Case study 9: Hauptbahnhof II, (SMART) apartments, Vienna	44
Case study 10: Maierhof subsidised housing, Bludenz, Vorarlberg	48
Case study 11: Querbeet, social housing, Vienna	52
Case study 12: Subsidised intergenerational housing, Vienna	58
Case study 13: Multifunctional building, rapid housing, Vienna	63
Case study 14: Community housing, Mautner-Markhof Gründe, Vienna	68
<hr/>	
<b>4 / France</b>	<b>70</b>
Social, co-operative, and affordable housing in France	71
Case study 15: Maréchal Fayolle housing, 16th Ar., Paris	73
Case study 16: Infill social housing, Paris	76
Case study 17: Infill social housing, Belleville, Paris	79
Case Study 18: Mixed use building with social housing, Paris	83
Case study 19: Social housing, Argenton Sur Creuse	87
Case study 20: Prefabricated social housing, Nogent-le-Retou	89
Case study 21: Suburban housing, Ivry-sur-Seine	92
Case study 22: Renovated and extended building, Tourcoing	96

<b>5 / Germany</b>	<b>98</b>
Social, co-operative, and affordable housing in Germany	99
Case study 23: Residential and studio building, Berlin	100
Case study 24: Co-operative housing, River Spreefeld, Berlin	106
Case study 25: R50 – cohousing, Berlin	111
Case study 26: wagnisART co-operative housing, Munich	115
Case study 27: Masterplan, Traumhaus Funari, Mannheim	120
Case study 28: Affordable housing, Frankfurt	124
Case study 29: Micro-apartments, Georgengarten, Hannover	127
<hr/>	
<b>6 / The Netherlands</b>	<b>131</b>
Social, co-operative, and affordable housing in the Netherlands	132
Case Study 30: Holland Park West, Diemen	134
Case study 31: Multi-generational housing including live work-spaces, Katwijk	136
Case study 32: Groene Mient, co-operative housing, the Hague	138
Case study 33: Timmerhuis, mixed use architecture, Rotterdam	142
Case study 34: Block A, Noordstrook, social housing, Amsterdam	145
Case study 35: Startblok Riekerhaven, experimental housing, Amsterdam	148
Case study 36: De Flat Kleiburg, Amsterdam	150
Case Study 37: Mix of houses and apartments, Arnhem	154
<hr/>	
<b>7 / Denmark</b>	<b>156</b>
Social, co-operative, and affordable housing in Denmark	157
Case study 38: Low income apartments, Dortheavej, Copenhagen	158
Case study 39: Saltholmsgade, social housing, Aarhus	162
Case study 40: Low income apartments, Fredriksberg	166
Case study 41: Sustainable and affordable dwellings, Hvalsø	167
Case study 42: Almenbolig+, standardised, affordable housing, Copenhagen	170
Case study 43: UN17 eco village, Copenhagen	173
Case study 44: The Iceberg, mixed development, Aarhus	177

# Introduction

←  
Go to  
contents

The security and dignity of a good quality home is one of the most important and liberating qualities in society. The challenge of providing an adequate supply of affordable, sustainable homes to meet present and future needs is not unique to Ireland.

This report draws on 44 case studies of recent social, affordable, and co-operative housing projects in Switzerland, Austria, France, Germany, the Netherlands, and Denmark, that respond in their own way to this challenge.

Housing architecture is a product of the policies and design and building practices and societal and cultural norms that have evolved in a particular place, over time. The context and country within which a development takes place will give rise to specific planning, regulatory (including fire), and other safety requirements. The architecture will not necessarily transfer easily from one place or country to another, but there are lessons to be learnt from looking at the context, challenges and design solutions arrived at within different contexts and in different countries.

The report includes public projects led by government or city authorities, mixed tenure private developments, and collective schemes led by residents. Like Ireland, all the selected countries have an established tradition of providing housing that is not purely market oriented to meet a portion of their housing need. However, the delineation of tenure is not always straightforward. Most of the countries chosen, to varying extents, provide a mixture of tenures within individual projects. Recent housing policies have frequently favoured tenure integration, with a portion of the residents receiving rental subsidies within mixed tenure developments. Also, affordable, and co-operative developments often include a mixture of homeowners, and people renting, with and without government subsidies. For this reason, the report, as well as providing examples of housing built specifically for the social housing sector, also includes examples of private sector lead, mixed tenure developments, and other projects that fall outside the traditional understanding of social housing.

Architecture, at its best, provides a creative response to the diversity and complexity of modern housing and sustainable living. Although many of the case studies are exemplars of best practice in housing design, it

is not necessarily so for all 44 of the case studies included in this report. The aim is to provide, using readily available web-sourced examples, an overview of the range of recent housing typologies that exist in the selected countries, and to highlight, within individual projects, a point, or points of interest, that may be worth considering, within an Irish context.

The COVID-19 crisis and the need for people to stay at home and in their local neighbourhood has impacted on most people, including parents caring for young children or elderly relatives and juggling work and family commitments, students and others who temporarily share accommodation who are forced to spend extended periods of time in each-others' company, people, including many older people, who are socially isolated, and those living with physical disabilities and chronic ill health. The crisis has highlighted the need for well-designed, adaptable homes that support individual and community well-being and that are technologically smart. These case studies demonstrate that, as well as providing an individual with a place to live, well designed housing enhances the lives of its residents, contributes to existing communities, supports economic well-being, and helps to protect the environment.

The Housing Agency would like to thank the many architects, photographers, and illustrators whose work is included in the report, many of whom provided useful feedback on draft versions of the case studies. In addition to drawing extensively on information on projects provided in architectural publications and the websites of individual architectural practices the report also draws on web-based sources such as [archdaily.com](http://archdaily.com), [dezeen.com](http://dezeen.com), [divisare.com](http://divisare.com) and [archello.com](http://archello.com), on magazine articles in the Architectural Review and in the magazine, DETAIL. Every effort has been made to identify and name the sources, authors, and photographers of the projects, and to obtain their consent. All sources are acknowledged with gratitude.

**Isoilde Dillon**  
**The Housing Agency**

# 1 / Elements of good housing design – points from case studies

←  
Go to  
contents

The following are some of the elements, identified from the case studies, that contribute to the creation of successful designs, and good places to live.

## 1

**Ambition, imagination and flexibility:** many of the projects have resulted from taking a pragmatic approach that enables solutions to arise from imaginatively considering how the architecture, in addition to addressing housing supply, responds to the social, economic, environmental, and cultural needs of society.

### Case study 36: De Flat Kleigburg, Amsterdam, the Netherlands

An ambitious programme to regenerate an existing estate and provide residents with the opportunity to create their own homes. This project shows that, with imagination and a focus on community, existing buildings can have new life and have the potential to provide the most sustainable housing solutions.



De Flat Kleigburg, Amsterdam, the Netherlands

© NL Architects and XVW Architectuur; © Photo Stijn Poelstra.

## 2

There is a general recognition of the need for housing schemes to be **affordable, particularly because rents and government subsidies are generally linked to construction costs.** However, because, the housing providers will, in many cases, be involved in the long-term management and maintenance of the developments this is balanced with a recognition of the need, to create **high quality durable buildings and sustainable communities.**

### Case study 3: Seven small apartments, Aarau, Switzerland

This project is both affordable and well detailed, using robust, low maintenance, good quality materials.



Seven small apartments, Aarau, Switzerland

© Gautschi Lenzin Schenker Architects; © Photo Andreas Graber.



### 3

**Designing for flexibility:** designing individual dwellings so that their internal layout can change, they can contract or expand over time, and can even accommodate a change of use from, for example, residential to commercial or vice versa, is increasingly seen as a key component of sustainability.

#### Case study 13: Multifunctional building – temporary rapid housing, Vienna, Austria

The structural system provides flexibility so the building can be economically converted into commercial property after this initial period of usage.

© trans\_city TC ZT; © Photo Daniel Hawelka.



Multifunctional building – temporary rapid housing, Vienna, Austria

### 4

Sustainability is also increasingly seen as **encompassing all 17 of the UN sustainability goals** – social, economic, environmental and cultural, and therefore housing is required to address issues such as **encouraging a healthy and sustainable lifestyle, the life cycle of materials, the biodiversity of a development, reductions in car usage, social inclusion, and the long term sustainability of communities.**

#### Case study 43: UN17 eco village, Copenhagen, Denmark

© Lendager Group, Årstiderne Arkitekter; © Visualisations:TMRW.



UN17 eco village, Copenhagen, Denmark

### 5

The value of **community and resident participation** in the design process; in addition to facilitating community cohesion, it can ensure that money is spent on what people actually consider to be important.

#### Case study 6: Bochardon co-operative housing, Lausanne, Switzerland

Cost reduction was achieved through consultation with future users.

© TRIBU Architecture, © Photo Michel Bonvin.



Bochardon co-operative housing, Lausanne, Switzerland



## 6

The value in looking at **innovative new forms of housing** for our towns and villages that emphasise design excellence.

### Case study 1: Hagmannareal Affordable Housing, Winterthur, Switzerland

A car-free, affordable apartment building in a Swiss village.

© Arge Hagmann-Areal, Soppelsa Architekten, Weberbrunner Architekten ag; © Photo Georg Aerni.



Hagmannareal Affordable Housing, Winterthur, Switzerland

## 7

The use of **pre-fabrication** as a means of providing high quality, affordable, sustainable housing.

### Case study 38: 66 Pre-fabricated low income apartments, Dortheavej, Copenhagen, Denmark

The high ceilings and floor to ceiling glazing contribute to the spatial quality of these affordable apartments.

© NL architects and XVW Architectuur; © Photo Rasmus Hjortshøj.



66 Pre-fabricated low income apartments, Dortheavej, Copenhagen, Denmark

## 8

The value of providing **a wide variety of housing typologies** within one development as a way of creating sustainable communities.

### Case study 10: Subsidised housing, Bludenz, Vorarlberg, Austria

The variety of homes provided aims to ensure social diversity within the Maierhof.

© Feld/72; © Photo Hertha Hurnaus.



Subsidised housing, Bludenz, Vorarlberg, Austria





## 9

Importance of having **generous circulation and well-designed shared facilities** and of locating these facilities where they are most likely to be used by the largest, and greatest variety of residents.

**Case study 12: Subsidised intergenerational social housing, Vienna, Austria**, with a variety of shared spaces.

© trans\_city TC ZT.



Subsidised intergenerational social housing, Vienna, Austria

## 10

The value of **carefully considering the floor plan**; how it can optimise the internal functional and aesthetic environment for the occupants and enhance their relationship to the external environment.

**Case study 7: Brüggläcker Housing Estate, Zurich, Switzerland**

© BS+EMI Architektenpartner AG, Zurich.



Brüggläcker Housing Estate, Zurich, Switzerland

## 11

An increasing awareness of the value of combining housing with green infrastructure that enhances bio-diversity.

**Case study 39: Saltholmsgade, social housing, Aarhus, Denmark**

© WE Arkitekter, and JWH Arkitekter.



Saltholmsgade, social housing, Aarhus, Denmark



# 12

That social housing has a role to play in **supporting innovation in design and construction**.

## Case study 20: Prefabricated sustainable social housing, Nogent-le-Retou, France

Innovation in housing construction.

© NZI Architectes, © Photo Juan Sepulveda Grazioli.



Prefabricated sustainable social housing, Nogent-le-Retou, France

# 13

The value of the **architectural competition system** as a way of procuring high quality, affordable designs and of ensuring that a countries' best architectural talent contributes to its housing and the frequency with which **smaller and less experienced practices partner with larger established practices**.

## Case Study 18: Mixed use building with social housing, Paris, France

© LAPS Architecture + MAB Arquitectura, © Photo Luc Boegly.



Mixed use building with social housing, Paris, France

# 14

**Parking standards** in the case studies vary from around one space per dwelling to car-free. In all the case studies where car parking is provided it is located at the periphery of the development or is provided underground.

## Case study 26: wagnisART co-operative housing complex, Munich, Germany

The absence of cars allows for a child-friendly open spaces that facilitate community cohesion.

© Bogevischs buero architekten stadtplaner GmbH & SHAG Schindler Hable, © Photo Jlia Knop.



wagnisART co-operative housing complex, Munich, Germany

←  
Go to  
contents

## 15

Good housing emerges where architects, planners, urban designers, community facilitators and housing practitioners in both the private and public sector, **work collaboratively and are open to thinking differently.**

**Case study 5: Kalkbreite complex, co-operative housing, Zurich, Switzerland,** combines a film theatre, a variety of apartment typologies, commercial space, a bed-and-breakfast, and a public courtyard in a single building.

© Photo Martin Stollenwerk.



Kalkbreite complex, co-operative housing, Zurich, Switzerland

# 2 / Switzerland

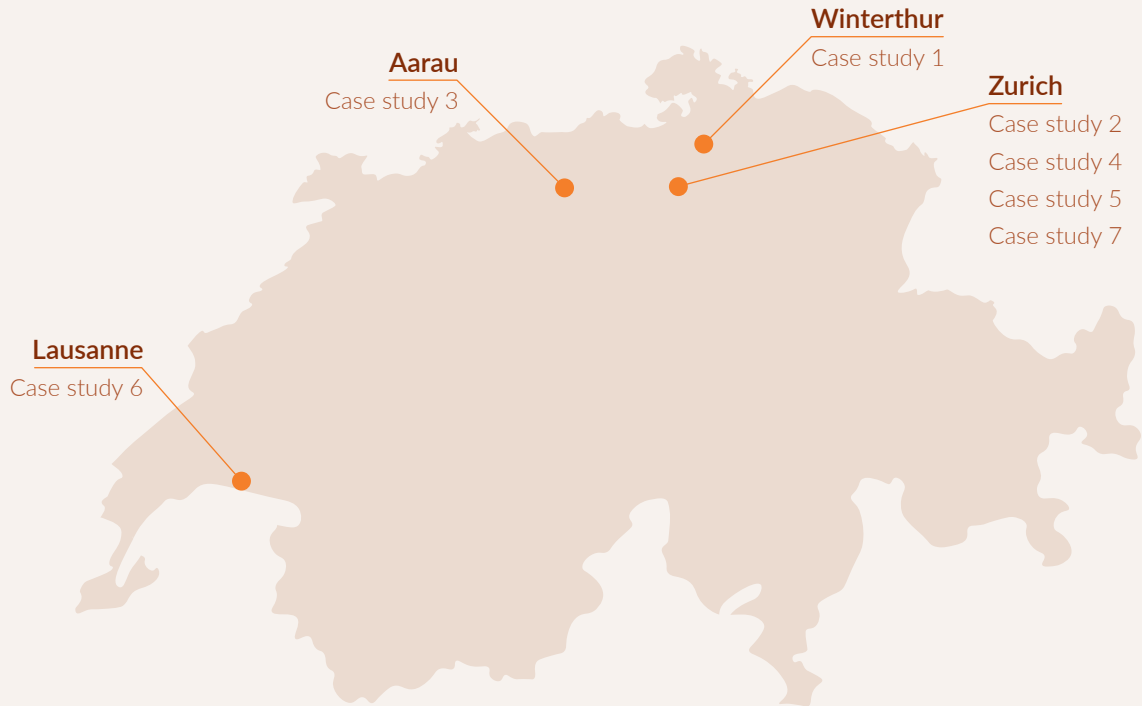

Social, co-operative, and affordable housing in Switzerland	11
Case study 1: Hagmannareal affordable housing, Winterthur	13
Case study 2: Affordable housing, Zurich	17
Case study 3: Seven small apartments, Aarau	20
Case study 4: Affordable apartment building, Zurich	23
Case study 5: Kalkbreite Complex, co-operative housing, Zurich	26
Case study 6: Bochardon co-operative housing, Lausanne	29
Case study 7: Brüggläcker housing estate, Zurich	33
Case study 8: Green City plot B3, Zurich	36

# Social, co-operative, and affordable housing in Switzerland



## Population

8,656,400 (2020)



## Dwellings

4,500,000 (2018)



## Tenure<sup>1</sup>

Social rent: 6%

Private rent: 51.5%

Owner occupier: 42.5%



## Housing providers<sup>2</sup>

Non-profit housing organisations and housing co-operatives

Switzerland has the highest average wealth per adult in the world. Switzerland is also a nation of renters: only 42.5 per cent of the population are home-owners, the lowest proportion in Europe. In Basel, 84 per cent of people rent their home and in Zurich three-quarters rent. The majority of tenants rent from private landlords and are protected by an armoury of regulations. Taxes on rental income are high, in total often exceeding 50 per cent, putting off many speculative get-rich-quick landlords.

The reason so many people rent in Switzerland, in many cases for life, is because of the historical availability of good quality rental housing and good legal protections for tenants. Banks also require high minimum deposits from mortgage applicants making home ownership unaffordable for many.

As a national average, households currently spend around 20 percent of disposable income on housing, fuel, and energy.

In Zurich, nearly one in four dwellings are owned either by a co-operative or a public foundation, providing rents one-fifth below market rates. 'Social housing', typically understood to be owned and provided by the state, is almost non-existent. These non-profit housebuilders not only provide

low-cost housing, but also encourage one of the healthiest architectural cultures in the world, running competitions for each project and supporting inventive housing design.

- Housing is considered in Switzerland to be a basic human need. The Federal Constitution says that the government needs to promote low priced housing and to make sure that there are enough affordable apartments for everyone.
- The 2003 Swiss Federal Housing Act reconfirms housing as a basic right and legislation supports co-operative housing.
- The major challenge for the country today is, as elsewhere, rising rents and a lack of low-cost housing and to find solutions to make housing available for everyone and to integrate the disadvantaged.
- Housing associations are non-profit and are required to provide rental housing at cost.
- Cantons, such as Lucerne, grant development licences for around 80 years to developers. Roughly approximating to a leasehold, this model sees land ownership remain with the city, whilst developers receive a licence to construct buildings on it and retain ownership of the buildings for the duration of the contract, and pay an annual rent equivalent to 2-2.5% of the land value. When the contract reaches an end, ownership of the licence and the

Nearly **1 in 4** dwellings are owned by a co-operative or public foundation in Zurich

**84%** of people rent their home in Basel

Around **20%** of Swiss households disposable income is spent on housing, fuel, and energy

1 Eurostat Housing Statistics (2020)

2 Karausevc, Paul and Batchelor, Abigail: Social Housing Definitions and Design Examples, RIBA Publishing (2017).

←  
Go to  
contents

buildings on the land reverts to the city in exchange for payment of 80 percent of its market value at that point in time.

- Switzerland, is facing many of the challenges being faced throughout Europe (co-operative housing, which often requires individuals to pay to be members of the co-operative, is not necessarily low-cost), but, as the median voter rents, there is a strong incentive to provide good quality rental accommodation and to provide good legal protection for residents.

### Points of special interest

- Non-profit organisations and housing co-operatives have an interest in good quality because of the need to consider long-term maintenance.
- The extensive use of the competition system by non-profit organisations and housing co-operatives is seen as an effective way of procuring high quality, affordable housing.
- In Switzerland, space standards are generally generous. Not all areas have minimum space standards and a strong tradition of regional control allows for local flexibility.
- Note the high standards of construction and excellent quality of finishes.

### References

Eurostat Statistics Explained: [ec.europa.eu/eurostat/statistics-explained/index.php?title=Housing\\_statistics#Tenure\\_status](https://ec.europa.eu/eurostat/statistics-explained/index.php?title=Housing_statistics#Tenure_status) (accessed October 2020).

Academy of Urbanism: [congress.academyofurbanism.org.uk/2019/05/16/a-very-swiss-approach-how-switzerland-approaches-affordable-housing-compared-to-germany-and-the-uk/](https://congress.academyofurbanism.org.uk/2019/05/16/a-very-swiss-approach-how-switzerland-approaches-affordable-housing-compared-to-germany-and-the-uk/) (accessed October 2020).

LSE Research Online: [eprints.lse.ac.uk/68085/1/Hilber\\_Housing%20policies%20in%20Switzerlandn.pdf](https://eprints.lse.ac.uk/68085/1/Hilber_Housing%20policies%20in%20Switzerlandn.pdf) (accessed October 2020)

Architectural Review: [www.architectural-review.com/how-housing-co-operatives-built-a-city/10012449.article](https://www.architectural-review.com/how-housing-co-operatives-built-a-city/10012449.article) (accessed October 2020).

# Case study 1: Hagmannareal affordable housing, Winterthur

Live work affordable village apartments

←  
Go to  
contents



## Location

Arbergstrasse 7a, 8408 Winterthur,  
Switzerland



## Architects

Arge Hagmann-Areal, Soppelsa  
Architekten & Weberbrunner  
Architekten ag



## Client

The Hagmann Family

## Links

[hagmann-areal.ch/index.php/projekt.html](http://hagmann-areal.ch/index.php/projekt.html)

[weberbrunner.eu/project/wohnerbauung-arbergstrasse-winterthur](http://weberbrunner.eu/project/wohnerbauung-arbergstrasse-winterthur)

[www.archdaily.com/930107/hagmannareal-housing-development-arge-hagmannareal-plus-weberbrunner-architekten-ag-plus-soppelsa-architekten?ad\\_source=search&ad\\_medium=search\\_result\\_projects](http://www.archdaily.com/930107/hagmannareal-housing-development-arge-hagmannareal-plus-weberbrunner-architekten-ag-plus-soppelsa-architekten?ad_source=search&ad_medium=search_result_projects)

## Project details

**No. of dwellings:** 50 apartments (Phase 1)

**Area:** 7,870 m<sup>2</sup>

**Mix:** All affordable

**Procurement:** Architectural competition

**Construction:** Timber-concrete hybrid

### Energy

#### performance:

A timber-concrete hybrid construction with a wooden façade that minimises the use of grey energy. Combined with an approved mobility concept, the goals of the 2000-watt society were achieved

**Car spaces:** Car free

**Cost:** The cost of the building (plot excluded) was around 21 million swiss francs (€19.3 million)

**Year:** 2018

© Photo Georg Aerni



←  
Go to  
contents

### Description<sup>3</sup>

The architectural competition sought a car-free, affordable apartment building with an architecturally and ecologically superior design.

The development contains two typologies: the existing courtyard house – an existing former carpentry shop – and the new building with three wings that wind around a central courtyard and range from three to six storeys.

The existing building, in which various co-operatively organized craftsmen are accommodated, is integrated into the new residential building project. This creates a lively place to live and work amid an exciting mix of uses and preserves the identity and history of the village and the Hagmann family. These uses are complemented by a medical practice for general practitioners on the ground floor of the new building.

Additional rooms that can be temporarily added to an apartment, flexible floor plans that enable alternative forms of living and are attractive for people of different

ages, as well as outdoor rooms that can be used all year round, contribute not only to the mix of uses, but also to creating a socially sustainable environment.

Inspired by recent concepts for non-profit co-operatives, social sustainability is supported by promoting communal forms of living and a balanced mix of residents. Thus, there is a sauna for all residents, common rooms and gardens, a square with a bar and pizza oven in a renovated railway carriage, a children and adults playground, and a boule terrain. Monthly in-house events in the bar demonstrate that the hoped-for community is already growing.

### Note

- **This residential ensemble is a prime example of how housing densification can provide a positive impetus for a village.**
- **Flexible floor plans enable alternative forms of living and contribute to creating a sustainable development.**
- **The development includes a range of facilities to support the community.**

---

<sup>3</sup> Edited version of architect's description provided in archdaily.com.









Ground floor plan

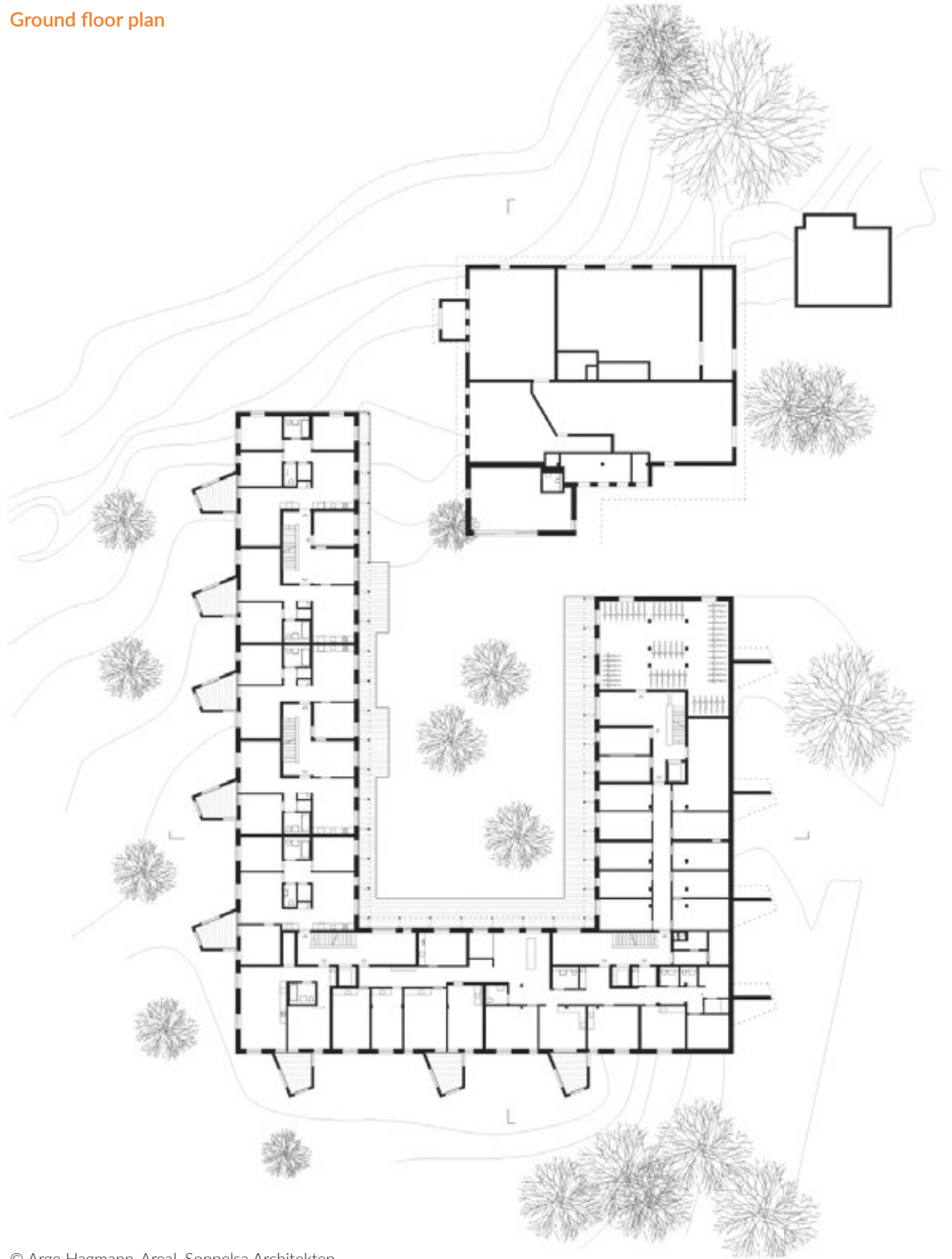

© Arge Hagmann-Areal, Soppelsa Architekten,  
Weberbrunner Architekten ag.

# Case study 2: Affordable housing, Zurich

←  
Go to  
contents

## Urban social housing



### Location

Zurich, Switzerland



### Architect

Lütjens Padmanabhan



### Client

Stiftung PWG

### Links

[www.luetjens-padmanabhan.ch](http://www.luetjens-padmanabhan.ch)

[www.architectural-review.com/buildings/communal-luxury-social-housing-zrich-switzerland-by-ltjens-padmanabhan/10044408.article](http://www.architectural-review.com/buildings/communal-luxury-social-housing-zrich-switzerland-by-ltjens-padmanabhan/10044408.article)

### Project details

<b>No. of dwellings:</b>	21 apartments (mostly 3 bed)
<b>Mix:</b>	All social
<b>Procurement:</b>	Architectural competition
<b>Car spaces:</b>	17
<b>Year:</b>	2018



© Photo H el ene Binet

### Description<sup>4</sup>

In 2013, L utjens Padmanabhan won an invited competition to build 21 apartments in the suburb of Oerlikon for Stiftung PWG, a non-profit, public foundation of the city of Zurich which owns and manages 1,787 apartments and 316 commercial properties.

As in most Swiss housing blocks, the ground floor is dominated by a buggy park and lavish laundry rooms which move space-hungry clutter from individual homes.

“Just because housing is low-cost doesn’t mean it can be built cheaply”, the architects explain, because there is a limit on how cheaply housing can be built due to Swiss standards and construction costs and wages. “But what you can do is design apartments where more people live within the surface area.” Here, front doors open onto a ‘kitchen-hall’: simultaneously a kitchen, dining room, living area and hallway, with the other rooms opening from it and a loggia at one end.

Zurich does not have specific enforceable space standards, however standards are comparatively generous, 76.5 m<sup>2</sup> for a one-bedroom flat. Pitched at families, most of the building’s 21 flats are three-bedroom.

The architects note that co-operatives and public foundations are satisfying clients to work for because “they invest in durable high-quality materials to keep the maintenance costs low”. The same organisation builds, manages and leases the housing, so there is a motive to emphasise longevity, something that is often missed in developments sold for a quick profit. Details are robust and simple.

<sup>4</sup> Edited version of description provided by Eleanor Beamont in September 2019 edition of the Architectural Review.



The residents represent a cross-section of society from all walks of life. Not only does this produce a mix of different people in each building but it also ensures that co-operative and public foundation housing models have support from across the political spectrum.

**Note**

- Use of durable materials, internally.
- Ground floor laundry and buggy park.
- Unusual floor plans with direct access to the kitchen/dining and living area, and inclusion of a smaller separate living space.

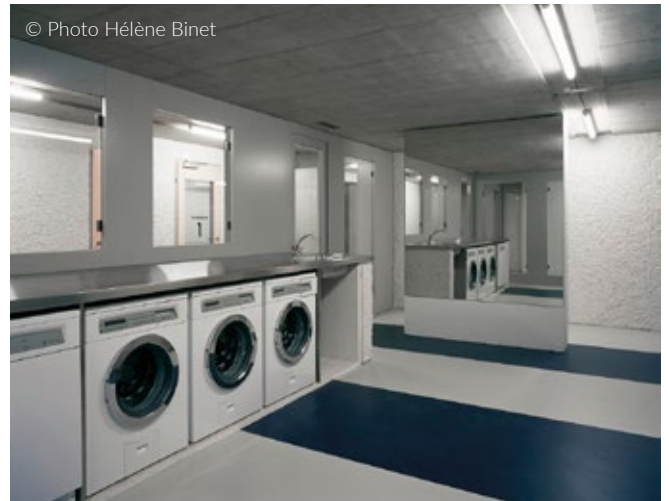

Ground floor plan

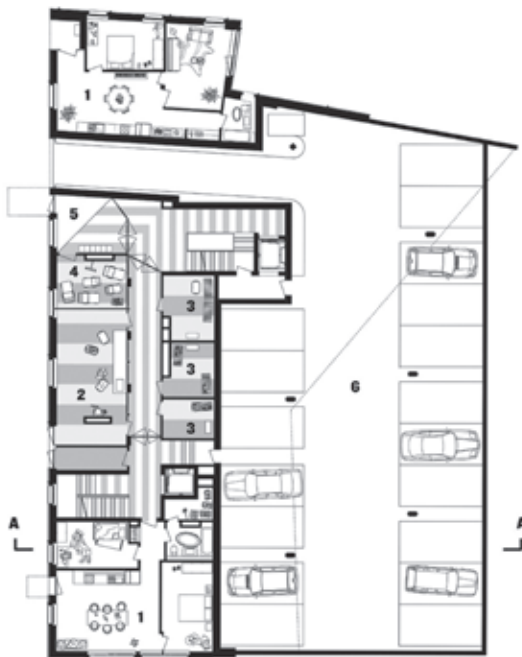

© L utjens Padmanabhan

Fourth floor plan



© L utjens Padmanabhan



First floor plan



# Case study 3: Seven small apartments, Aarau



## Economic apartment building



### Location

Aarau, Switzerland



### Architect

Gautschi Lenzin  
Schenker Architects

### Links

[www.glsarch.ch/projekt-aarau-hohlgasse](http://www.glsarch.ch/projekt-aarau-hohlgasse)

[www.archdaily.com/photographer/andreas-graber?ad\\_name=project-specs&ad\\_medium=single](http://www.archdaily.com/photographer/andreas-graber?ad_name=project-specs&ad_medium=single)

### Project details

<b>No. of dwellings:</b>	7
<b>Area:</b>	475 sqm overall
<b>Mix:</b>	7 small apartments
<b>Construction:</b>	Concrete wet cell boxes
<b>Energy performance:</b>	The building meets the Minergie P standard
<b>Year:</b>	2019

© Photo Andreas Graber



←  
Go to  
contents

### Description<sup>5</sup>

This new three-storey building with attic was created in the garden city neighbourhood of Aarau. The building comprises seven small apartments. The floor plans are structured by wet cell boxes, cabinet, and kitchen fixtures. The back of the building is designed as a solid, closed element to shield off the emissions of the busy street and the tram line.

Visible concrete surfaces and hot-dip galvanized metal components emphasize the raw appearance of the building. Dark glazed solid wood windows, the dark wood belt floor, and the warm grey carpentry refine the interior.

### Note

- **Economic floor plan and good use of materials, used to create a striking building in a suburban setting.**

---

<sup>5</sup> Edited version of architect's description provided in archdaily.com.

© Photo Andreas Graber





© Photo Andreas Graber

### First floor plan



© Gautschi Lenzin Schenker Architects



# Case study 4: Affordable apartment building, Zurich



## Affordable apartments/densifying suburbs



### Location

Albisrieden, Zurich, Switzerland



### Architect

Gus Wüstemann Architects



### Client

The Baechi Foundation

### Link

[www.guswustemann.com](http://www.guswustemann.com)

### Description<sup>6</sup>

The Baechi Foundation contracted Gus Wüstemann Architects to build a housing block in Zurich with a high living quality on a low budget.

<sup>6</sup> Edited version of text provided on architect's website.

### Project details

**No. of dwellings:** 9

**Area:** Four, two-bedroom apartments of 60 m<sup>2</sup> and five, three-bedroom apartments of 95 m<sup>2</sup> each

**Mix:** Two bedroom and three bedroom apartments

**Procurement:** Commission

**Construction:** Concrete

**Energy performance:** Minimum space standards for some elements with an emphasis on community contribute to reducing energy consumption

**Year:** 2019

© Photo Gus Wüstemann Architects

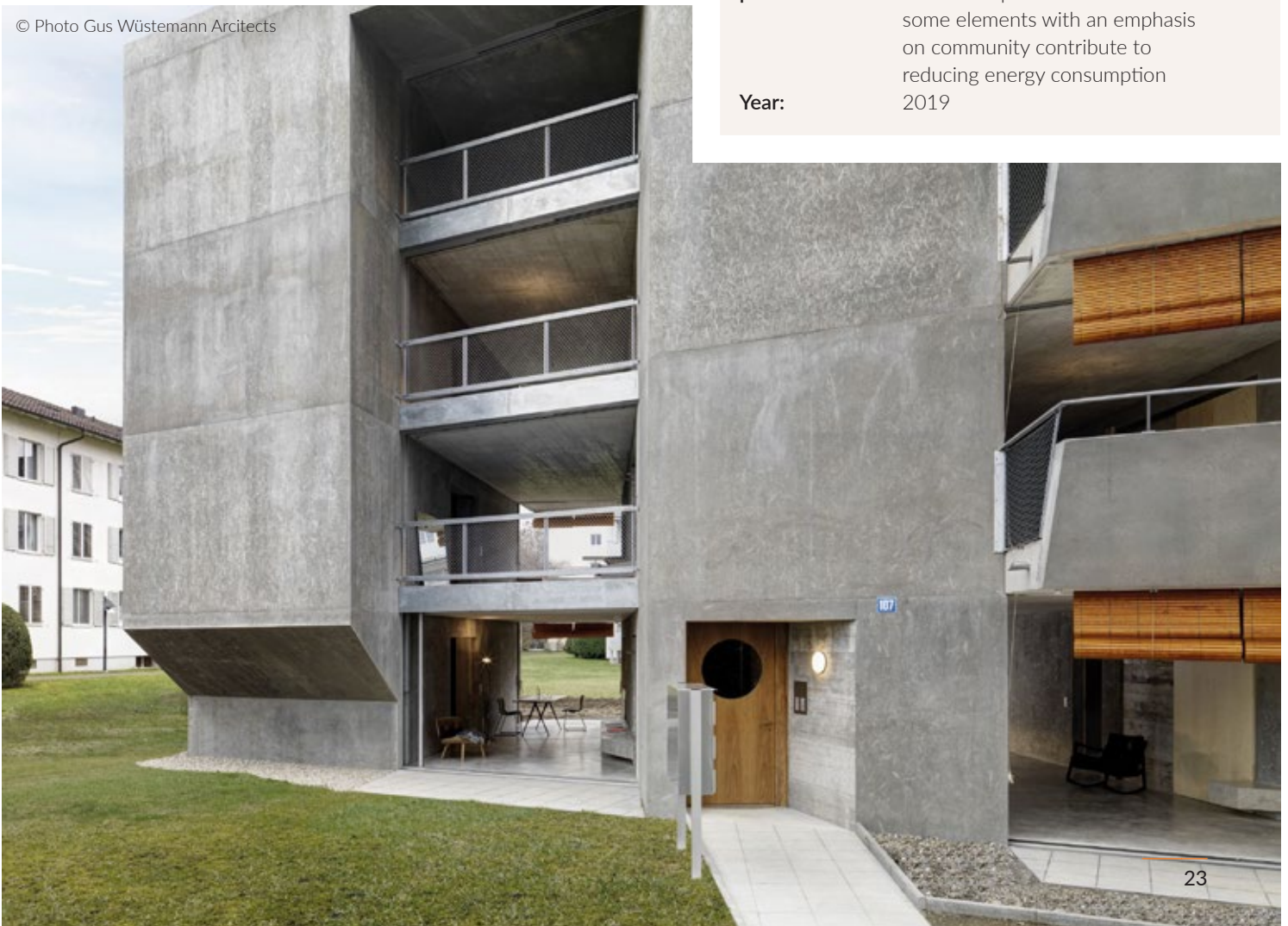



The massive, concrete apartment building stands on a green space in Zurich's district of Albisrieden and is surrounded by blocks of flats from the 1950s. The floor plan is trapezoidal and divided in two by the central access core. Each storey has two apartments, with the exception of the attic, which features a single apartment and a large rooftop terrace. The building's nine flats are distributed over five storeys; each one measures either 60 or 95 m<sup>2</sup>. The new building is located on a green piece of land as part of the plan to increase density within the city, and is a solitaire, among the adjacent linear buildings.

Rents relate to construct costs; the rents had to be affordable and the rent is amongst the cheapest in the city of Zurich.

The architects focussed on a couple of interventions that add major value to the quality of the living spaces. Gus Wüstemann Architekten make the case for a reconsideration of residential building, putting a greater emphasis on the community aspect of sustainability.

**Note**

- The project seeks to demonstrate that by targeting interventions in light and space, and at the same time reducing the amount of private accommodation and focussing on community, it is possible to create an interesting and attractive living environment.



**Ground floor plan**

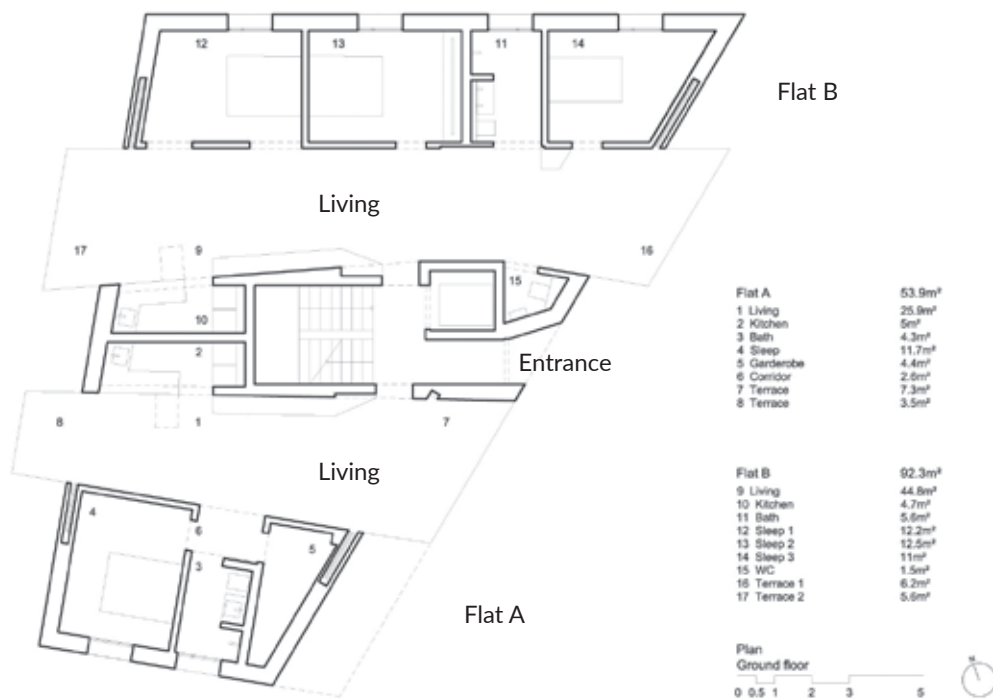

© Gus Wüstemann Architects



# Case study 5: Kalkbreite Complex, co-operative housing, Zurich

←  
Go to  
contents

Mixed use and co-operative housing



## Location

Zurich, Switzerland



## Architect

Müller Sigrist Architekten



## Client

Kalkbreite Co-op/the city  
of Zurich

## Links

[www.muellersigrist.ch/arbeiten/bauten/wohn-und-gewerbesiedlung-kalkbreite-zuerich](http://www.muellersigrist.ch/arbeiten/bauten/wohn-und-gewerbesiedlung-kalkbreite-zuerich)

[www.archdaily.com/photographer/michael-egloff?ad\\_name=project-specs&ad\\_medium=single](http://www.archdaily.com/photographer/michael-egloff?ad_name=project-specs&ad_medium=single)

## Project details

**No. of dwellings:** 88 and 9 rentable extension rooms and 20 spaces for cultural uses and 200 workspaces

**Mix:** Apartments and commercial

**Procurement:** City run competition

**Construction:** The seven-storey building is a hybrid construction with a façade of prefabricated wood elements

**Energy performance:** Meets the Minergie-P-Eco standard

**Year:** 2014

© Photo Martin Stollenwerk

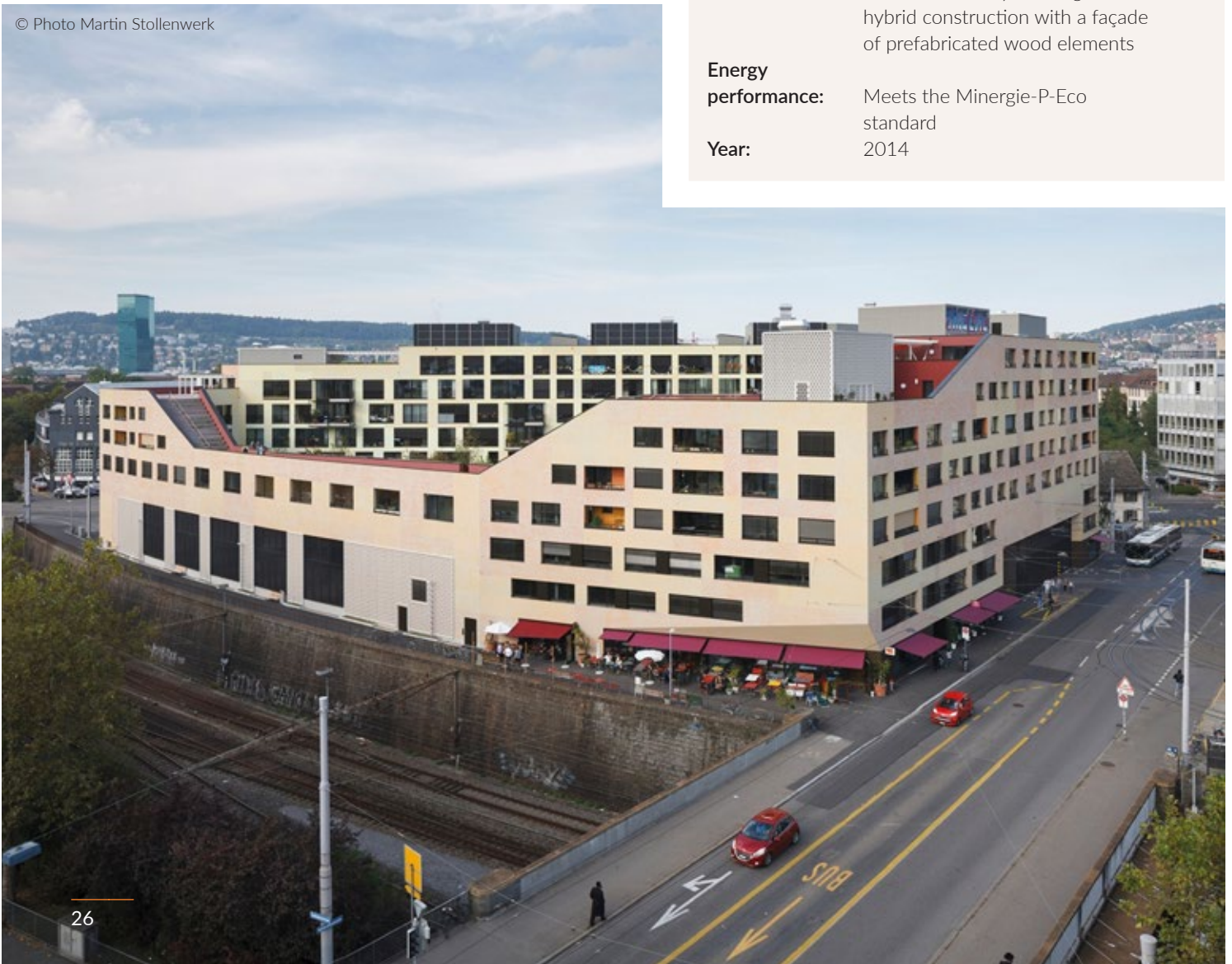

←  
Go to  
contents

### Description<sup>7</sup>

The residential and commercial complex with integrated tram depot stands at a prominent point marking the boundary between two city districts. It combines a film theatre, 97 apartment units housing about 250 people, 5,000 square meters of commercial space, a simple bed-and-breakfast, and a public courtyard in an identity-lending, large but compact form.

A cascade of access points links indoors and outdoors, walkable roofs and a courtyard above the tram depot. The building complex contains 88 flats, there are 9 “jokers,” small units (about 28 m<sup>2</sup>) with private bathrooms but no kitchens, distributed throughout the project and available for time-limited rental for commercial or residential use, and various communal areas as well as cultural, catering, retail and service premises for 256 residents and 200 workers. Hence Kalkbreite offers new and flexible forms of living and

working, serving as a model for co-operative living in the city.

The complex was built according to the energy and ecology targets of the 2000-watt society and meets the Minergie-P-Eco standard. The seven-storey building is a hybrid construction with a façade of prefabricated wood elements. The plaster walls of the polygonal perimeter block development dazzle in colours ranging from orange to turquoise.

### Note

- This mixed-use development has been cited as an example of how to make co-operatives viable in the 21st century.
- The building contains different dwelling ‘clusters’ – stand-alone dwellings, dwellings plus shared living areas and dwellings plus shared living and dining areas.



© Photo Martin Stollenwerk

Part plan indicating the variety of living arrangements

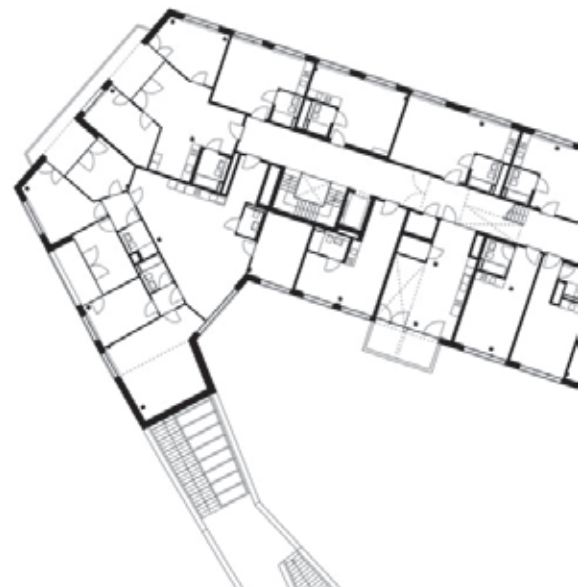

© 2020 Müller Sigrist Architekten

<sup>7</sup> Edited version of architect’s description provided in [archdaily.com](https://www.archdaily.com).



Section with tramlines running below

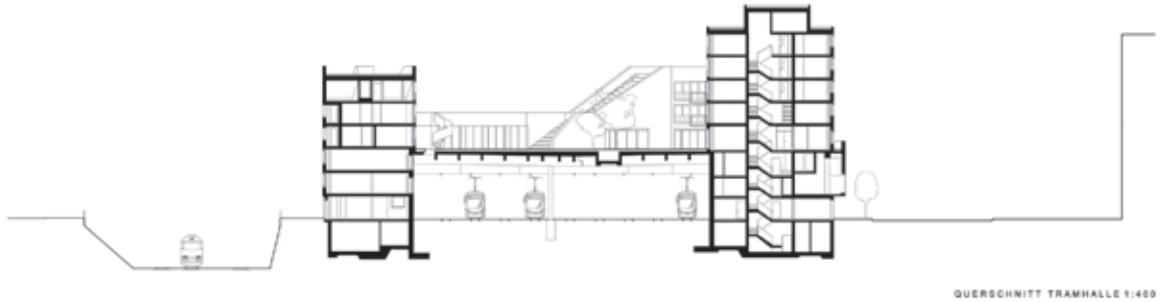

© 2020 Müller Sigrist Architekten

Residential courtyard level plan

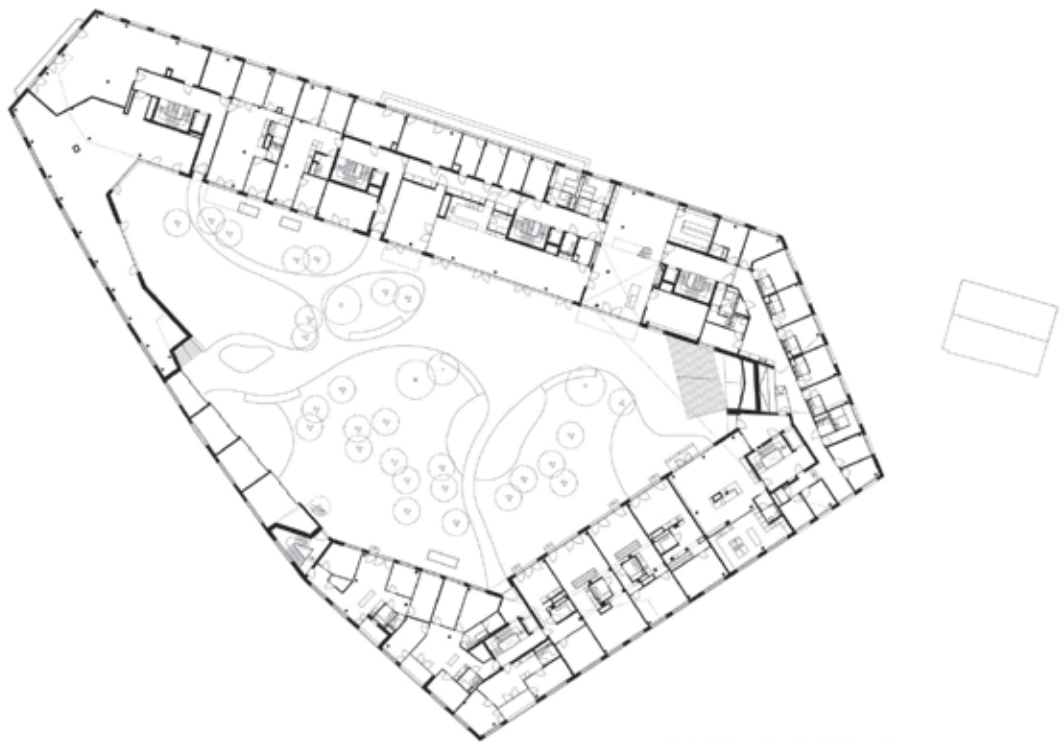

© 2020 Müller Sigrist Architekten

# Case study 6: Bocharдон co-operative housing, Lausanne

←  
Go to  
contents

## Co-operative housing



### Location

Chemin de Bocharдон  
11, 1012 Lausanne,  
Switzerland



### Architect

TRIBU Architecture

### Links

[tribu-architecture.ch/projets/43/bocharдон](http://tribu-architecture.ch/projets/43/bocharдон)

[www.archdaily.com/804412/13-cooperative-housing-in-lausanne-tribu-architecture?ad\\_medium=gallery](http://www.archdaily.com/804412/13-cooperative-housing-in-lausanne-tribu-architecture?ad_medium=gallery)

### Project details

**No. of dwellings:** 13 apartments and 1 studio for a student

**Area:** 1,372 m<sup>2</sup>

**Construction:** Concrete

**Energy performance:** Use of healthy materials (no or less volatile organic compound releases for example, with lowest CO<sub>2</sub> possible)

**Cost:** 6,000,000 CHF (2016)  
(€5,590,000)

**Year:** 2016

© Photo Michel Bonvin



←  
Go to  
contents

### Description<sup>8</sup>

This project is located in the district of Chailly in Lausanne, close to public transport. The project is composed of 13 apartments, a common room, a common room for events, a studio for a student, a laundry room and external spaces.

The future inhabitants participated actively in the design of the project, which made it possible to reduce building costs (for example by limiting the number of parking spaces to the minimum required by the regulations and the creation of a car-sharing scheme) and by adapting the common spaces to meet residents' needs. The large balconies serve as solar protection in summer, without cutting the solar contributions in winter. The dual aspect apartments guarantee natural ventilation, in addition to the "simple flow". The following themes were discussed in workshops with the future inhabitants:

- Construction regulations
- Private life
- Common life
- Mobility
- Materials
- Building physics
- Structure

### Note

- **Increased site supervision provided to ensure environmental requirements achieved.**
- **Cost reduction achieved through consultation with future users (for example through agreement to car-share and thereby reduce parking requirements).**

---

8 Edited version of text provided on architect's website.







←  
Go to  
contents

### Ground floor plan

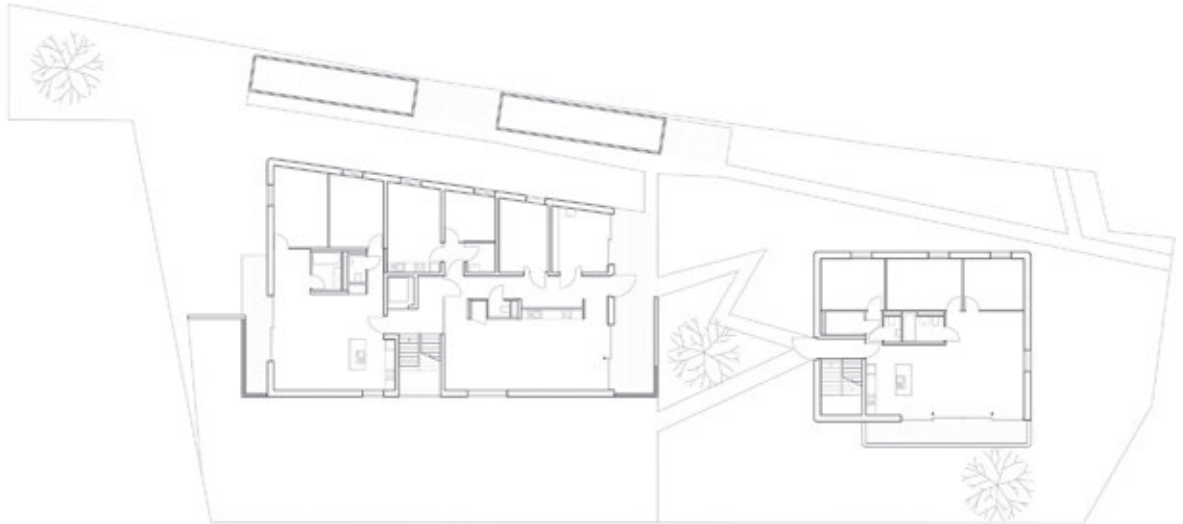

© TRIBU Architecture



### Level 2 floor plan



© TRIBU Architecture



# Case study 7: Brüggläcker housing estate, Zurich



## Suburban co-operative housing



### Location

Zurich-Schwamendingen,  
Switzerland



### Architect

BS+EMI  
Architektenpartner  
AG

### Project details

**Procurement:** Competition  
**Year:** 2014

### Description<sup>9</sup>

The Brüggläcker Housing Estate is located in the area between Oerlikon and Schwamendingen where a small-scale district of single-family homes meets the housing rows of Albert Steiner's garden city. The three-story buildings adopt the height of their neighbours, and their staggered outdoor spaces interweave the new buildings with the green space of the surroundings. The full size of the building cannot be grasped from any one position, helping

### Links

[www.emi-architekten.ch/projekt/bruegglaecker](http://www.emi-architekten.ch/projekt/bruegglaecker)

[www.world-architects.com/en/edelaar-mosayebi-inderbitzin-architekten-zurich/project/bruegglaecker-housing-estate-1](http://www.world-architects.com/en/edelaar-mosayebi-inderbitzin-architekten-zurich/project/bruegglaecker-housing-estate-1)

<sup>9</sup> Edited version of architect's description provided on architect's website and in [archdaily.com](http://archdaily.com).

© Photo Roland Bernat





to create a scale and intimacy appropriate to the neighbourhood.

The apartment layouts are developed from alternating relationships to the exterior. With their open-plan living and dining rooms, the elongated apartments stretch between the two garden spaces and have exposures on at least two, or in the case of the end units, three sides. Continuous outdoor rooms set in front of the east and west façades heighten the

porosity between indoor and outdoor space. The usable floor area of the apartments is planned to a minimal degree, thus enabling a variety of living situations.

**Note**

- Sensitive densification with close attention paid to the relation of the building to the site and well thought out floor plans.



**Upper floor plan**

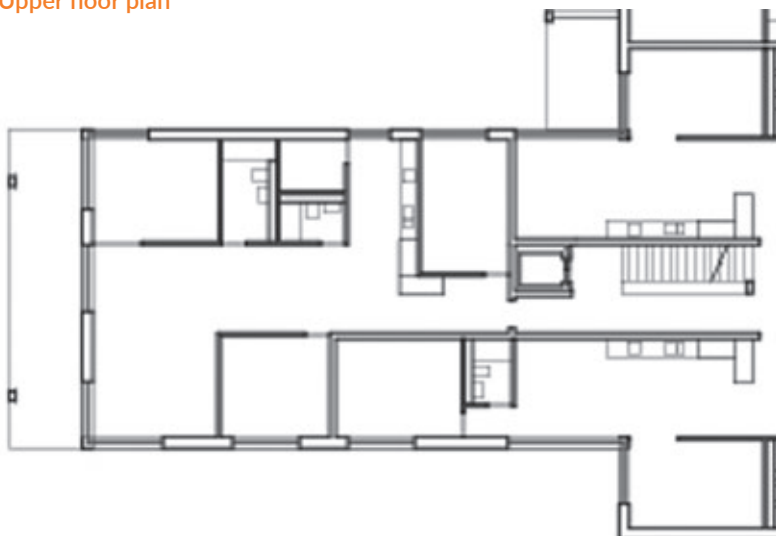

© BS+EMI Architektenpartner AG, Zurich

←  
Go to  
contents

### Upper floor plan



'The importance of the floor plan ... that's something that needs to be pointed out. The floor plan in a housing project determines the life that can happen, or not happen. It's crucial.' Arbeit am Grundriss ('Working on the plan') is a methodology Inderbitzin and his partners habitually apply to EMI projects, whose floor plans are tightly threaded and irregular conglomerations of rooms which often reference historic examples. Efficient in area, they are nonetheless configured in ways that are not always obvious – fostering oblique sight lines, peripatetic movement and moments of surprise rarely found in the average low-cost housing development.<sup>10</sup>

<sup>10</sup> Christian Inderbitzin of Zurich practice Edelaar Mosayebi Inderbitzin (EMI): [www.architectural-review.com/how-housing-co-operatives-built-a-city/10012449.article](http://www.architectural-review.com/how-housing-co-operatives-built-a-city/10012449.article)

# Case study 8: Green City plot B3, Zurich



Collective/social housing



### Location

Maneggstrasse 73, 8041 Zurich



### Architect

Adrian Streich Architekten AG



### Client

Genossenschaft Hofgarten,  
Zurich

### Links

[www.adrianstreich.ch/](http://www.adrianstreich.ch/)

[archello.com/project/greencity-baufeld-b3-sud](http://archello.com/project/greencity-baufeld-b3-sud)

[www.archdaily.com/915854/green-city-residential-building-adrian-streich-architekten-ag?ad\\_medium=gallery](http://www.archdaily.com/915854/green-city-residential-building-adrian-streich-architekten-ag?ad_medium=gallery)

### Project details

**No. of dwellings:** 44

**Area:** 8,331 sqm (87% residential)

**Mix:** Families, older people, immigrants

**Energy**

**performance:**

The building is certified to the standard Minergie ECO for ecological and energy saving buildings

**Cost:** 23,000,000 CHF (€21,400,00) (total) 4,452 CHF (€4,149)/m<sup>2</sup>

**Year:** 2017

© Photo Roland Bernath

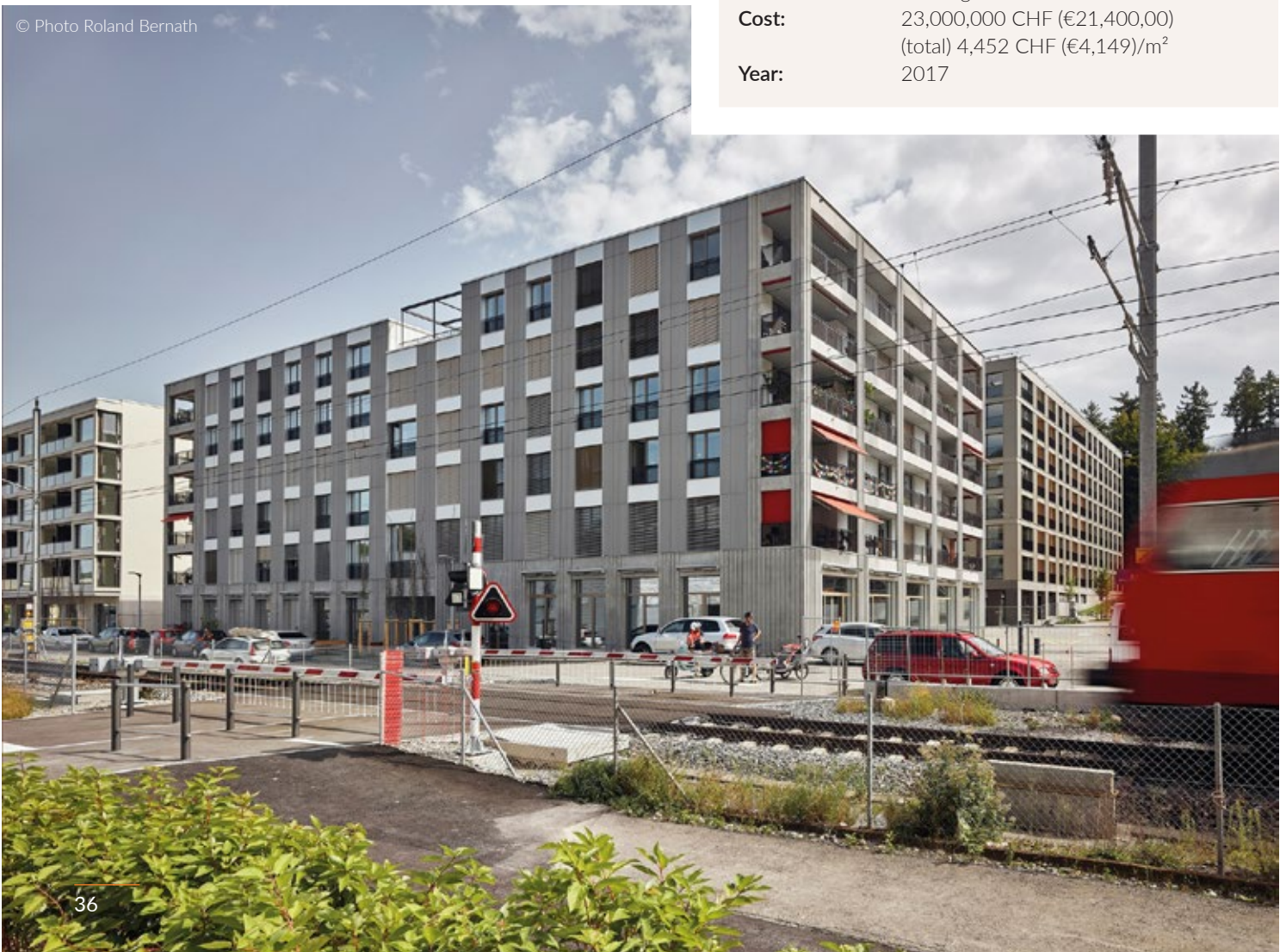

←  
Go to  
contents

### Description<sup>11</sup>

On the southern outskirts of Zurich, the Green City Manegg development forms an island between the Sihl river and the highway. Following centuries of industrial encroachments into city space, Green City Manegg is becoming one of Zurich's last large urban expansions close to the city itself. Plot B3 south is one of the smaller housing complexes.

From a generously proportioned, shared lobby, two stairwells each provide access to four residential units per storey. A half-storey offset between the two halves of the building results in different room heights on the ground floor. The ground floor has a room height of 4.3 m facing towards Spinnereiplatz. It is home to a bakery cum café and the common room for all non-profit housing co-operatives on the site. Smaller studios are located in the northern section of the ground floor with a room height of 3.6 m.

The 10 m x 8 m courtyard creates a shared centre for the building. A ring of balconies arranged on the split level serves as a private outdoor space and

simultaneously facilitates visits between neighbours. This ring of balconies has no escape route function and can be furnished as desired. Shared conservatories and rooftop terraces on the first upper storey and attic storey are accessible to all residents.

The flats in the centre are grouped around the courtyard. Living and dining rooms of these flats meander around this interior open space.

In addition to the areas facing the shared courtyard, all flats have more private living room areas oriented to the outside.

On the ground floor there are common rooms to rent for the residents, and for other residents of the neighbourhood. There is also a bakery and cafe which has an important impact on the newly built neighbourhood. The offices of the co-operative are also based on the ground floor. There are 4 apartments with additional height in the ground floor to allow living and working in the same spaces.

Common spaces and shared living: the big common spaces on the ground floor are open to everyone. The internal common room on the first floor, the workshop, the courtyard, the roof terraces and the laundrette provide a wide range of community spaces for the residents to meet.

Since the rent in co-operative housing in Zurich is directly related to the total costs of construction, the construction costs have to be as low as possible to match with the previously established rents. Nevertheless, the co-operative wanted a high standard of building and long-lasting materials.

Since the co-operative is a non-profit institution the rents are based only on the total costs of construction and maintenance costs. This leads to a reduction of circa 33% compared to market prices.

### Note

- Successful use of internal circulation as a social space, facilitated by separating the internal circulation from the fire escape routes.
- The layout provides for both private and shared spaces.



11 Edited version of architect's description provided in [archdaily.com](https://www.archdaily.com).

←  
Go to  
contents

Ground floor plan



© Adrian Streich Architekten AG

© Photo Roland Bernath







First floor plan



© Adrian Streich Architekten AG

Fifth floor plan

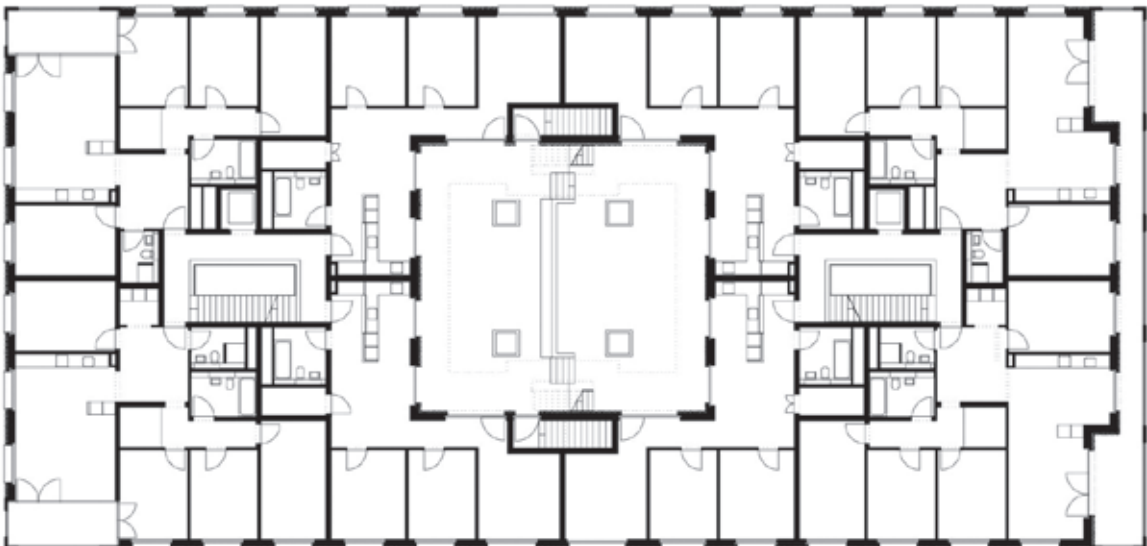

© Adrian Streich Architekten AG



Section

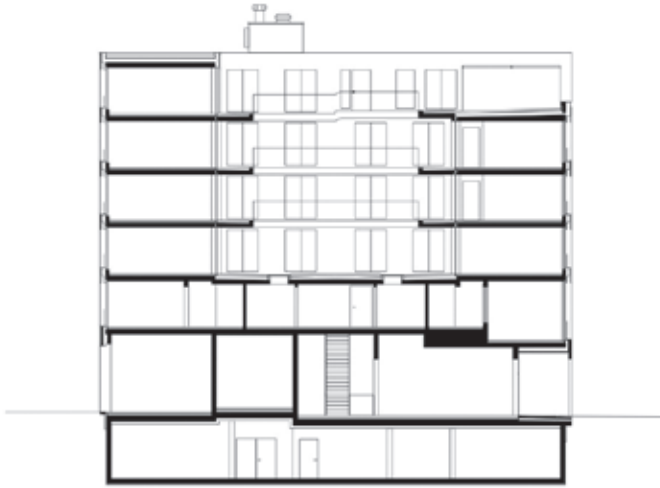

© Adrian Streich Architekten AG

Apartment plan



© Adrian Streich Architekten AG

Part floor plan

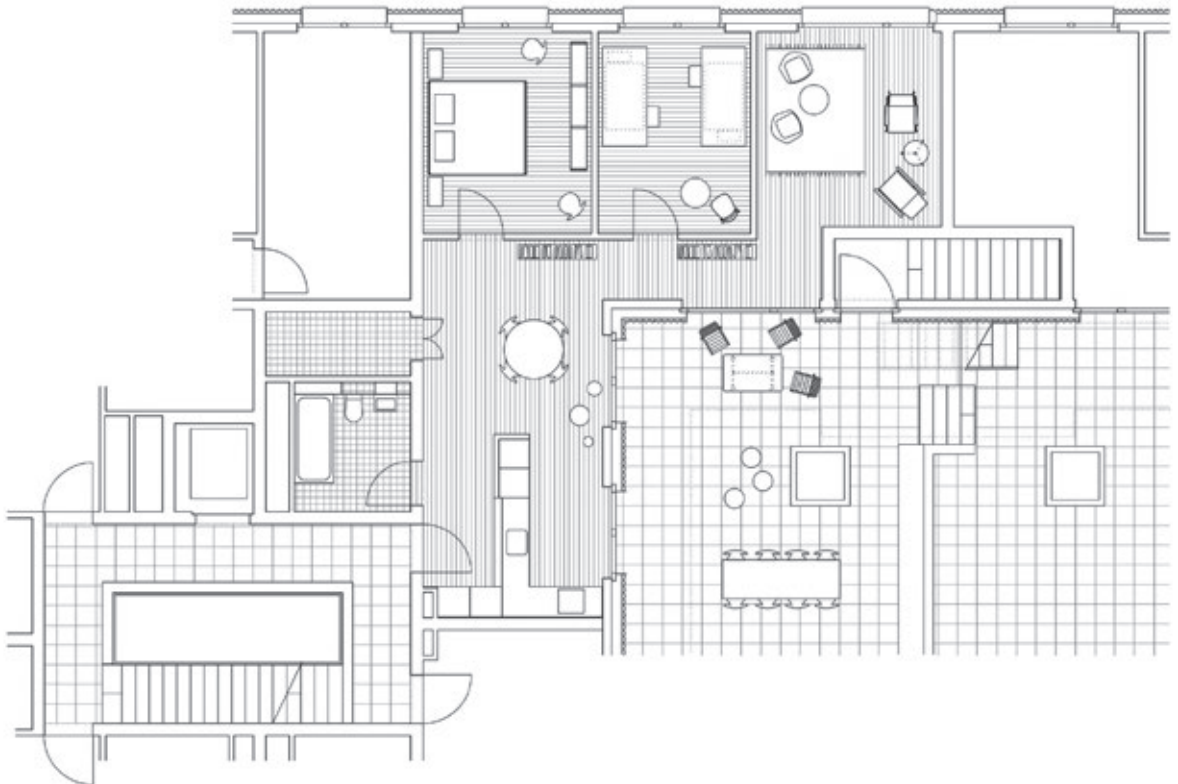

© Adrian Streich Architekten AG

# 3 / Austria

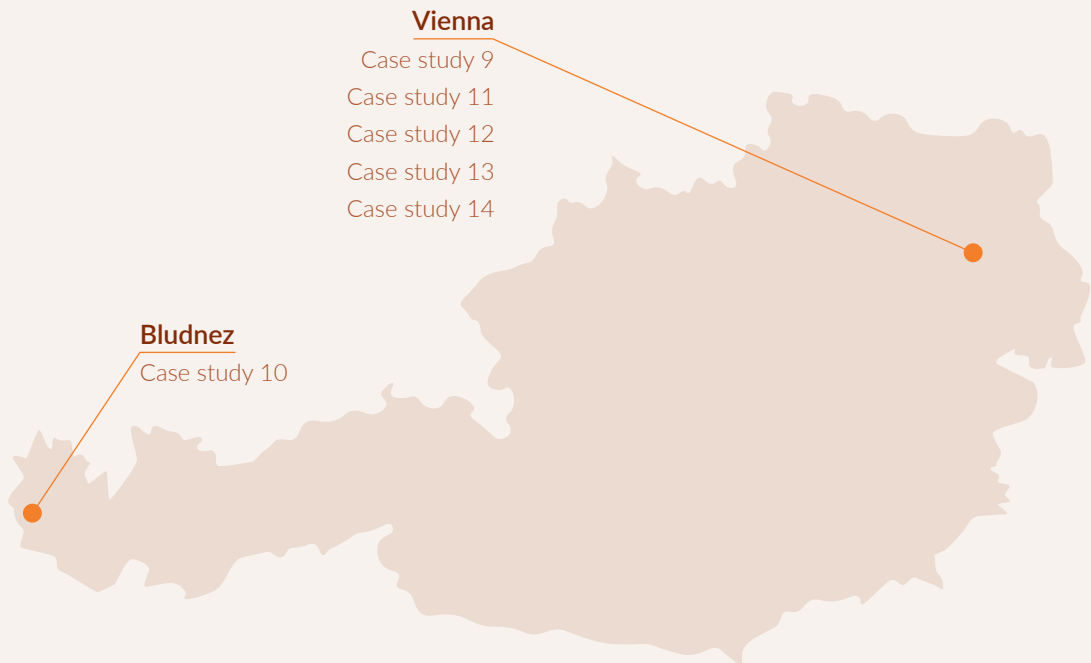

Social, co-operative, and affordable housing in Austria	42
Case study 9: Hauptbahnhof II, (SMART) apartments, Vienna	44
Case study 10: Maierhof subsidised housing, Bludenz, Vorarlberg	48
Case study 11: Querbeet, social housing, Vienna	52
Case study 12: Subsidised intergenerational housing, Vienna	58
Case study 13: Multifunctional building, rapid housing, Vienna	63
Case study 14: Community housing, Mautner-Markhof Gründe, Vienna	68

# Social, co-operative, and affordable housing in Austria



## Population

8,859,000 (2019)



## Dwellings

441,400 (2011)



## Tenure<sup>12</sup>

Social rent: 20.1%  
Private rent: 28.3%  
Owner occupier: 51.6%



## Housing providers

Municipalities, limited profit sector (including co-operatives and companies), also limited provision by for-profit providers

In Austria, state intervention in housing development is significant. Public funds are available through an elaborate system of “Housing Promotion Schemes” whose goals are to ensure sufficient good quality housing, to provide investment capital, and to make housing affordable to people. The subsidies provided are generally direct object-specific, meaning that the financial assistance is given directly to the housing co-operatives and is geared towards the construction costs as opposed to the subject-specific subsidies, which are directed to individuals.<sup>13</sup>

The creation of integrated and economically mixed communities is a priority and the social housing sector in Austria responds to publicly defined goals and principles such as economic, ecological, and social sustainability. The main provisions are that rents should cover costs, profits are limited, and the companies have an obligation to reinvest. The funds for the housing systems are financed by a fixed, earmarked proportion of income tax, as well as corporation tax and ‘housing contributions’ paid by all employees.

Austria has strong rent regulation. In principle, both social and private rents are regulated and cost-based. Austria’s biggest landlord remains the City of Vienna, which owns around 220,000 rental apartments while 60% of all Vienna households are subsidised apartments. Around 43% of all apartments in Vienna are permanently tied to a use determined by social concerns.

In 1984 the Land Procurement and Urban Renewal Fund was established as a central agency for building projects by non-profit developers. This fund, now known as the wohnfonds\_wien is still acquiring sites. The wohnfonds\_wien organises developer competitions. The body of independent experts meets monthly and assesses every subsidised housing project according to urban planning, architectural, energy and social criteria, and also evaluates building costs and leases. Projects applying for funding that fail to meet the board’s requirements must be revised. For developments of 300 apartments upwards a developer’s competition is compulsory. Developers and architects submit a design, along with details and costs. Around 10,000 social housing apartments are

Around **220,000** apartments are owned by the City of Vienna, Austria’s biggest landlord

**60%** of all Vienna households are subsidised apartments

Around **43%** of all apartments in Vienna are permanently tied to a use determined by social concerns

<sup>12</sup> Karausevc, Paul and Batchelor, Abigail: Social Housing Definitions and Design Examples, RIBA Publishing (2017).

<sup>13</sup> About Austria: [www.housinginternational.coop/co-ops/austria](http://www.housinginternational.coop/co-ops/austria) (accessed October 2020).

←  
Go to  
contents

erected every year using this system. For first time occupants' rents are currently around €7 per square metre. An initial one-off contribution of about €60 per square metre is required. To circumvent this, council building, which was dropped in 2003, has been revived and today new council apartments, without the requirement for a one-off payment are being re-introduced.<sup>14</sup>

As elsewhere, in Austria, market liberalisation, privatisation of public housing, the retreat of corporatist governance traditions, and immigrant and social exclusion are issues that are being grappled with, but in Austria these debates occur within the context of a well-established social and affordable housing sector with an established history and record of achievement.

### Points of special interest

- Flexibility is built into many of the developments, allowing for individual homes to contract or expand to suit changes in household composition and life circumstances. Providing flexibility is frequently cited as a key element in achieving sustainability.
- Vienna, because of the acute demand for housing, and as part of its rapid build programme, introduced the concept of permanent buildings with fixed-term, rental housing occupancy on brownfield sites. These buildings are intended to provide the city with housing for part of their life-cycle but must be designed so that they can then be economically converted for other uses.
- The City of Vienna has introduced Flexible SMART (smaller) apartments with areas of 40 m<sup>2</sup>, 55 m<sup>2</sup> and 70 m<sup>2</sup> that are provided at affordable rents. These are often included within communities that also include other, larger homes and that have a good selection of community facilities.
- Austria has a well-developed developer and architectural competition system that appears to work well in delivering high quality, affordable, developments.
- The value of strong engagement with existing communities and future residents at design stage is widely recognised as important.
- Car parking standards are generally 1 or less per dwelling, depending on the location, and parking is generally either provided at the periphery of developments or underground.

### References

**About Austria:** [www.housinginternational.coop/co-ops/austria](http://www.housinginternational.coop/co-ops/austria) (accessed October 2020).

**New Statesman:** [www.newstatesman.com/spotlight/housing/2019/09/housing-basic-human-right-vienna-model-social-housing](http://www.newstatesman.com/spotlight/housing/2019/09/housing-basic-human-right-vienna-model-social-housing) (accessed October 2020).

<sup>14</sup> See Cost Effective Housing, DETAIL 4.2018.

# Case study 9: Hauptbahnhof II, (SMART) apartments, Vienna



## Low cost (SMART) apartments



### Location

Sonnwendquartier II,  
Vienna



### Architect

Geiswinkler &  
Geiswinkler Architekten



### Client

Heimbau

### Links

[geiswinkler-geiswinkler.com/buildings-detail/items/sonnwendviertel2.html?kat=1](https://geiswinkler-geiswinkler.com/buildings-detail/items/sonnwendviertel2.html?kat=1)

[inspiration.detail.de/sonnwend-ii-housing-development-in-vienna-114140.html?lang=en](https://inspiration.detail.de/sonnwend-ii-housing-development-in-vienna-114140.html?lang=en)

### Project details

**No. of dwellings:** 148 (116 'Smart' dwellings)

**Area:** Subsidised net. floor area  
11,450 m<sup>2</sup>  
SMART dwellings – 40 m<sup>2</sup>,  
55 m<sup>2</sup> and 70 m<sup>2</sup>

**Procurement:** Developer's competition

**Construction:** Reinforced concrete/flat roof

**Year:** 2016

### Description<sup>15</sup>

In the Sonnwend neighbourhood of Vienna, roughly 5,000 dwellings are being constructed.

As part of a competition stage, a further 400 residences were added with the theme of "smart living", a term that signifies a variable housing concept for small, low-cost dwellings.

The tenants' contribution is €56 per square metre for the utility value and the rental costs are €6 per square metre. Geiswinkler & Geiswinkler Architects have designed a total of 148 flats to a low-energy standard, of which 116 are "smart dwellings" with areas of 40 m<sup>2</sup>, 55 m<sup>2</sup> and 70 m<sup>2</sup>. Most of these units are dual aspect and have various layouts and functions – office, loft, shared flats, single or family dwellings.

The development relates to its existing urban context. The metropolitan, linear structure of the building is individualized by the private open spaces of the balcony zone. The design presents a strong presence: a diverse structure of balconies on the street side and colourful and varied arcades facing the courtyard.



© Photo Manfred Seidl

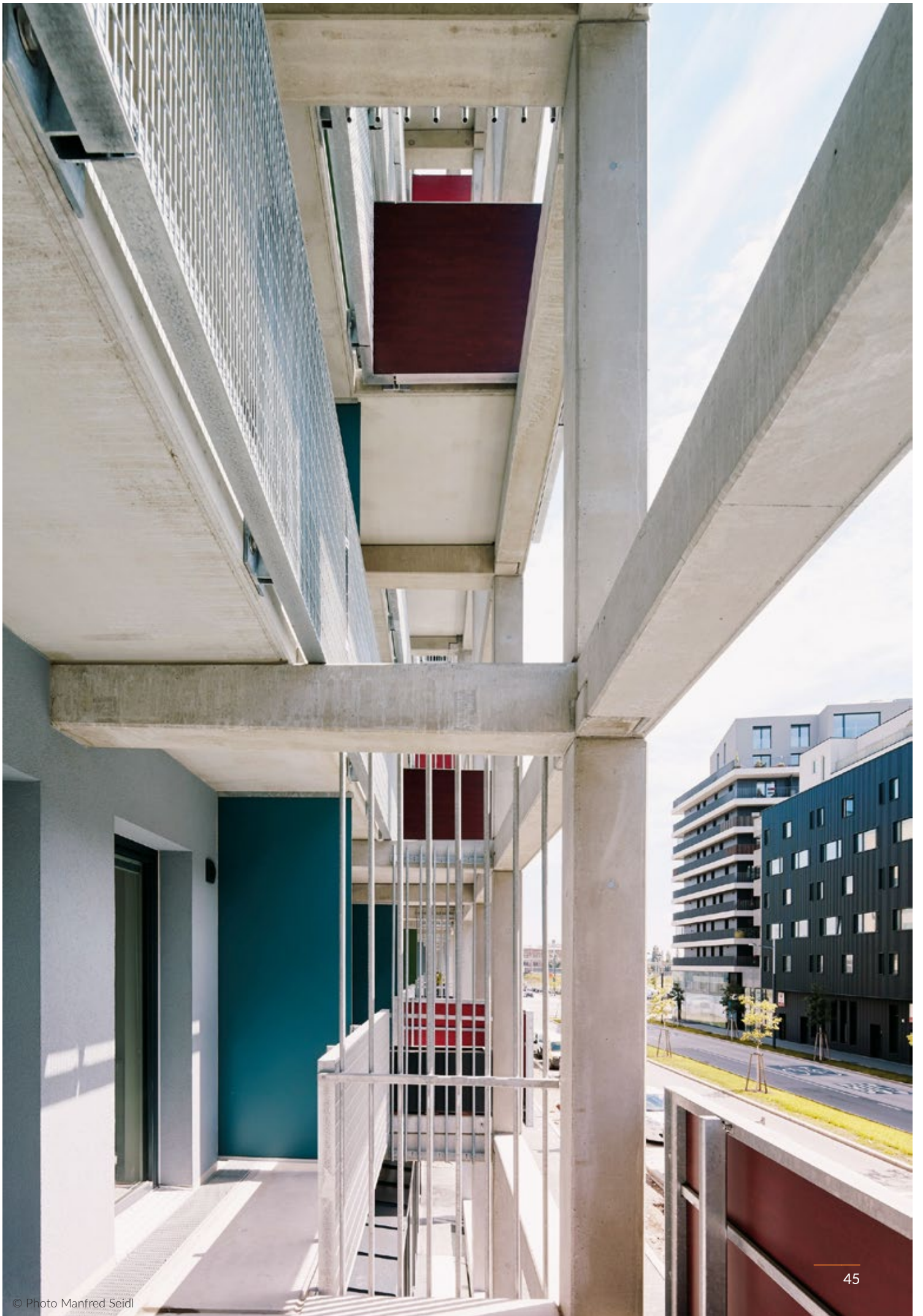



The courtyard arcades form a differentiated infrastructure network with attached community and adjoining rooms (laundry room, children's playroom, storage space for strollers and bikes) on each floor. The building aims to create a high quality sustainable residential environment, which provides the basis for good co-operation and a positive neighbourhood.

The apartments facing the street are dual aspect. The private outdoor areas are used as a filter layer to the noisy streets and the intensive vegetation is intended to improve the living climate.

The apartments of the two annexes – flanking the new urban square – are orientated not only to the city square, but also to the calmed garden zone. The threshold for the apartments acts as a vibrant communication space.

The SMART-apartments – for the first time the subject of a developer competition – combine compact living with very favourable equity and rents. At pre-construction stage future tenants had a say in the size and layout of dwellings and later, in the use of communal areas. Variations in the floor plan and in the open spaces are intended to provide additional individual scope and value to the residents.

### Note

- The project includes 116 design lead SMART apartments at affordable rents, 32 standard dwellings and a network of community rooms and facilities.

### Ground floor/site plan

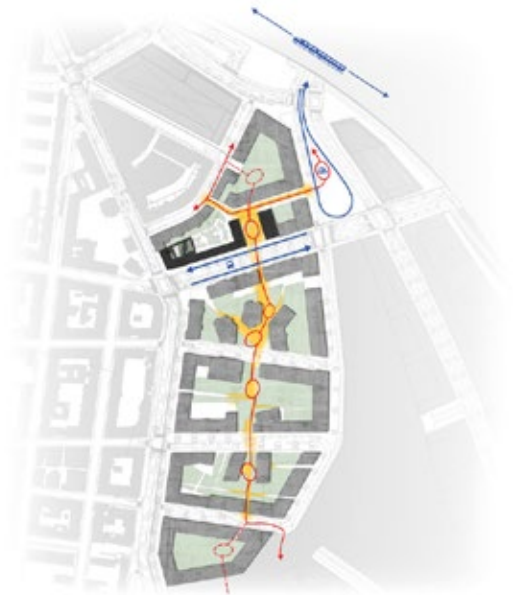

© Geiswinkler & Geiswinkler Architekten







### Ground floor/site plan



© Geiswinkler & Geiswinkler Architekten

### Upper floor plan



© Geiswinkler & Geiswinkler Architekten

# Case study 10: Maierhof subsidised housing, Bludenz, Vorarlberg



## Subsidised apartments



### Location

Bludenz, Vorarlberg, Austria



### Architect

Feld/72



### Client

Wohnbauselbsthilfe

### Links

[www.feld72.at/en](http://www.feld72.at/en)

[www.archdaily.com/924454/housing-development-maierhof-feld72?ad\\_source=search&ad\\_medium=search\\_result\\_projects](http://www.archdaily.com/924454/housing-development-maierhof-feld72?ad_source=search&ad_medium=search_result_projects)

[archello.com/project/housing-development-maierhof](http://archello.com/project/housing-development-maierhof)

### Project details

**No. of dwellings:** 67 apartments

**Area:** 4,500 m<sup>2</sup> living space, 37 m<sup>2</sup> for 1-room to 91 m<sup>2</sup> for 4-room apartments

**Mix:** Subsidised apartments for rent or sale

**Procurement:** Direct commission with prior study

**Construction:** Wood based hybrid construction, with a façade of prefabricated wood elements (box beams)

**Energy performance:** All houses have green roofs and solar thermal collectors

**Car spaces:** Underground parking (the site is mostly car free)

**Year:** 2019

© Photo Hertha Hurnaus



←  
Go to  
contents

### Description<sup>16</sup>

In the Austrian alpine town of Bludenz in Vorarlberg, feld72 have completed the housing development Maierhof.

The estate is situated within a community characterized by agriculture, old stables, single-family homes, and multi-storey residential buildings. The development consists of several small units that consist of an ensemble of eight three-storey buildings, with dimensions based on the original listed building – the “Zürcherhaus”. The houses, simply designed as compact cubes, appear identical at first glance. Nevertheless, no building is like the other. Each of the eight structures is differently aligned and sized to enable versatile visual relationships and to strengthen the village-like character. All houses have green roofs and solar thermal collectors.

A series of open spaces with different spatial qualities forms a significant part of the estate. Most of the area is car-free; the access to the underground car park runs along the northern part of the plot. The main access for pedestrians happens via the square in the southwest corner of the Maierhof at the interface to the neighbourhood. The square leads to the central

green courtyard, around which six of the eight buildings are grouped. This communal space offers room for play, meetings, access, and bicycle parking. The courtyard has been designed as a public space for the whole neighbourhood and is managed by the city together with the housing co-operative. All open spaces were designed by the landscape architecture studio GRUBER + HAUMER.

The eight buildings offer a diverse range of subsidised properties for rent and sale. The 67 apartments range in size from 37 m<sup>2</sup> for 1-room to 91 m<sup>2</sup> for 4-room apartments. All units include a private outdoor space (loggia). The variety of homes is to ensure social diversity within the Maierhof. A common room is provided to further promote social cohesion within the ensemble and beyond. Located on the ground floor at the entrance to the estate, it views the square on one side and the courtyard on the other side. The common room is managed by the city.

### Note

- A skilfully designed, attractive, socially diverse, town centre apartment scheme, using prefabricated wood elements and underground parking.

16 Edited version of architect's description provided in [archdaily.com](http://archdaily.com).



© Photo Hertha Hurnaus





Site plan

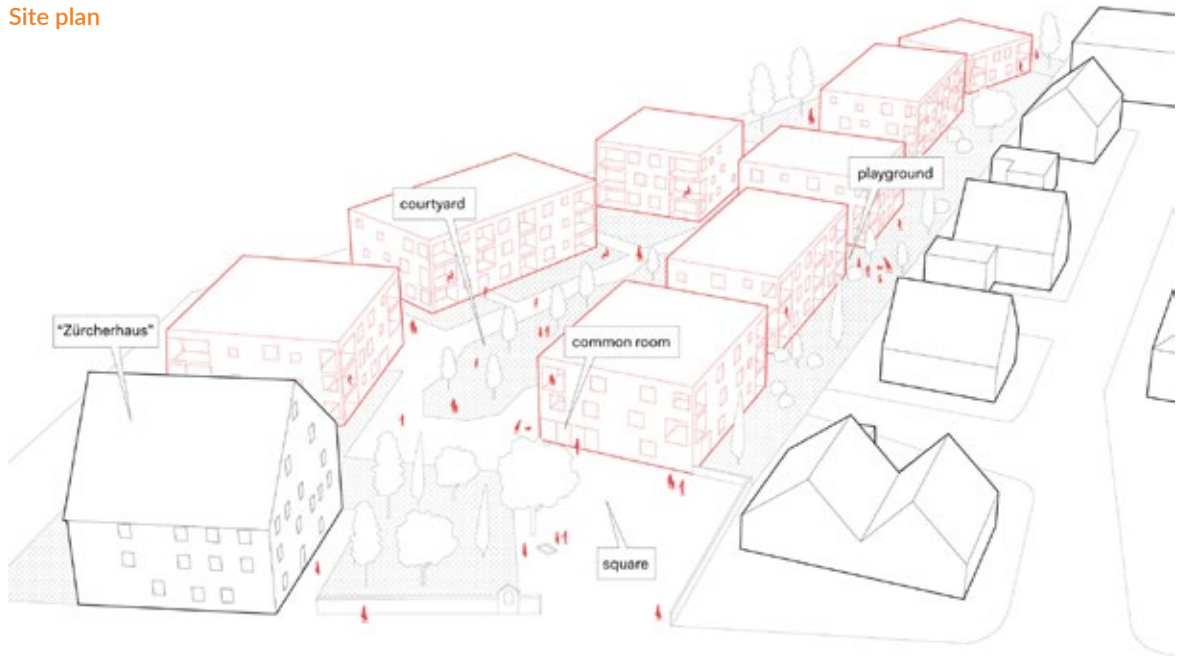

© Feld/72



© Feld/72



# Case study 11: Querbeet, social housing, Vienna



## Social housing



### Location

Helene-Thimig-Weg 9,  
1230 Wien, Austria



### Architect

Synn Architekten



### Client

ÖVW Österreichisches  
Volkswohnungswerk  
Gemeinnützige GmbH

### Links

[www.synn.at/Raume/Wohnen/querbeet/\(x\)/true/#all](http://www.synn.at/Raume/Wohnen/querbeet/(x)/true/#all)

[www.archdaily.com/934266/querbeet-social-housing-synn-architekten-zt-og?ad\\_source=search&ad\\_medium=search\\_result\\_projects](http://www.archdaily.com/934266/querbeet-social-housing-synn-architekten-zt-og?ad_source=search&ad_medium=search_result_projects)

### Project details

**No. of dwellings:** 243 subsidised apartments  
**Mix:** Social with 2 apartment types  
**Year:** 2017

### Description<sup>17</sup>

Embedded between the striking residential towers of Harry Glück in the west and a functional housing complex in the east, the urbanistic guiding idea “In der Wiesen Ost” takes on a mediating position between two very different approaches to the creation of living space, structurally as well as in terms of content.

The massive volume of the “Querbeet” project, which is part of the “In der Wiesen Ost” development, is

<sup>17</sup> Edited version of architect’s description provided on architect’s website and in [archdaily.com](http://archdaily.com).

© Photo Manfred Seidl



←  
Go to  
contents

divided into several parts: the towers at the north and south ends, the slender 3-storey angled brace and a 3-storey volume with overgrown balconies, the "greenbox". In the centre of the complex, a cantilever forms a usable, covered outdoor area - the market square. This is where the entrance to the kindergarten is located and a pavilion that can be used as a sales stand. The access to the exercise room and communal kitchen is also covered from here. This market square can be used as well as the common kitchen, which can be connected to the exercise room by a mobile partition wall to form a larger event hall. At the market square horizontal and vertical incisions allow views and illumination.

The structure of the building is reflected in the different façade solutions: the tower is designed with loggias, most of which are located at the corners of the building. Balconies with a raised side wall allow orientation to the southwest or southeast. Between individual balconies, slim concrete elements are suspended to create a second, "shelf-like" façade as a filter layer to the public space. The balconies of the "greenbox" lie behind a metal mesh as a climbing aid for the plants. The balconies are connected by horizontal elements to emphasize the privacy of the

balcony zone. Both loggias and balconies offer space for plant troughs, which are provided in cooperation with GreenLab.

The "querbeet" project provides a large number of different apartments. Basically, there are two types of floor plans: one "classic" type and one with a central sanitary unit, offering a different spatial experience and, above all, a wide range of adaptation possibilities – from loft to family apartment. The larger apartments are mainly arranged in the towers, elsewhere there are east- or west-oriented apartments in "regular" and "smart" design. The building is primarily accessed via four staircases – the two in the towers are designed as security staircases, the two middle staircases lead up to the communally used roof gardens on level 8.

#### Note

- **Two types of floor plan – one classic, and one with a central sanitary unit, to allow for different adaptations.**
- **Urban integration by having numerous communal spaces on the ground floor.**
- **Clever integration of green/open/social and shared spaces and creation of an urban garden carried through on balconies, loggias and flat roofs.**

© Photo Manfred Seidl









### Ground floor plan



© Synn Architekten

### Upper floor plan



© Synn Architekten



### Upper floor plans

Grundriss 4.OG



Grundriss 8.OG



© Synn Architekten

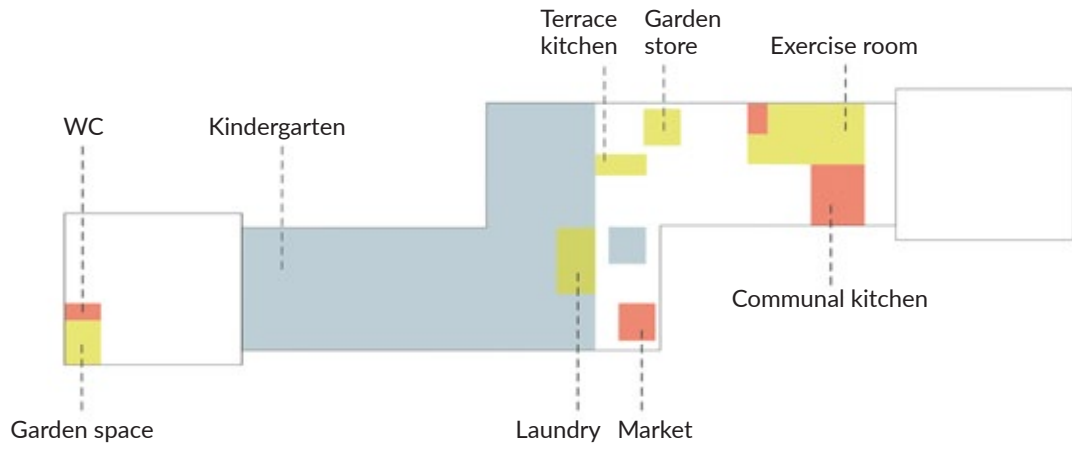

The communal kitchen and exercise room can be connected.

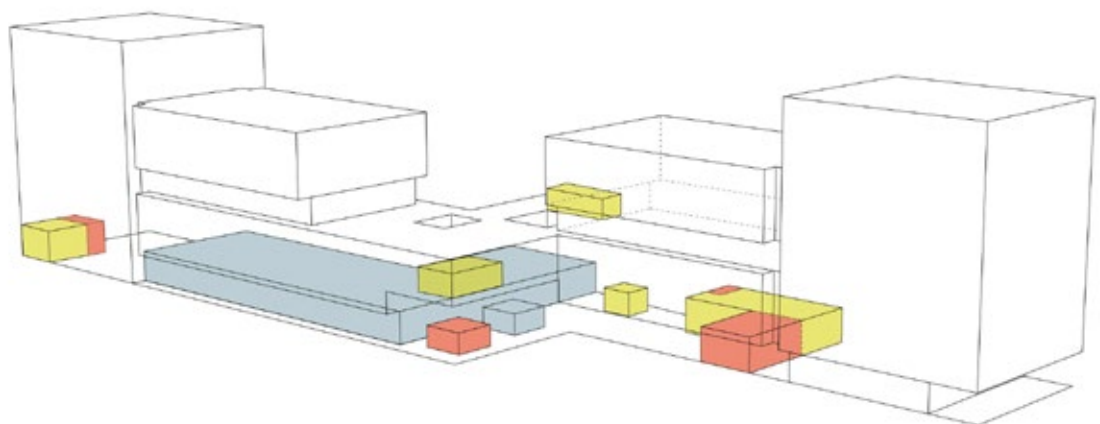
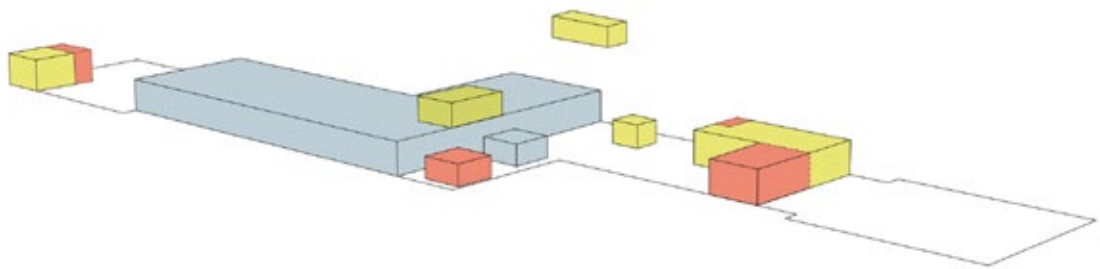

- External communal areas
- Internal communal areas
- Re-use of kindergarten

# Case study 12: Subsidised intergenerational social housing, Vienna



## Intergenerational living



### Location

Vienna, Austria



### Architect

Trans\_city TC ZT

### Project details

**No. of dwellings:** 128 and 1 shared apartment

**Area:** 9,963 m<sup>2</sup> usable living space

**Cost:** €13,500,000/€1,355/m<sup>2</sup>

WNFL

**Year:** 2018

### Links

[trans-city.at/tc/portfolio/stavangergasse/](https://trans-city.at/tc/portfolio/stavangergasse/)

[www.archdaily.com/940835/sta-zwei-plus-plus-intergenerational-housing-trans-city-tc?ad\\_source=search&ad\\_medium=search\\_result\\_projects](https://www.archdaily.com/940835/sta-zwei-plus-plus-intergenerational-housing-trans-city-tc?ad_source=search&ad_medium=search_result_projects)

### Description<sup>18</sup>

Zwei+plus is an innovative new concept for intergenerational living. It is subsidised social housing whose units are let in pairs to two cooperating, intergenerational households. These tandem households can be family or just plain friends, but they must move

<sup>18</sup> Edited version of architect's description provided on architect's website and in [archdaily.com](https://www.archdaily.com).

© Photo Hertha Hurmaus, Leonahard Hizensauer



←  
Go to  
contents

in concurrently and commit themselves to mutual co-operation and support. Zwei+plus provides tandem households with the chance to live together in the same estate: the paired yet spatially separate units are close enough for interaction and assistance, yet far enough apart, that privacy is preserved.

The architecture is the framework for an ambitious social program. Four L-Shaped buildings form green courtyards in which residents can gather. Collective spaces are grouped around the ground floor with a community café open to the surrounding neighbourhood, a laundromat with a playroom for children, a kindergarten, and an assisted living centre for senior citizens.

A co-operating partnership allows seniors to assist with the pre-schoolers.

The circulation zones in the upper floors are socially active spaces. The one-bedroom units which face onto the open galleries are outfitted with an innovative interpretation of the classic front-porch: a raised sitting area with open railing allows residents to see each other, and chat as they pass by.

The tandems have a wide choice of different floor plans. Most are self-contained apartments; some, so-called “all-smart” units, can house different households within one flexible dwelling. Two single parents can each have their own quarters while sharing a more spacious living-dining room. Or a family can live together while having a separately accessible studio unit for an elderly parent.

The precise articulation of the individual buildings in combination with the sensitive proportioning of the estate’s courtyards generates lively, well-structured exterior spaces. The wooden detailing of the balconies and ground floors provides a sense of warmth and intimacy, while the metallic- glazed finish of their finely planed surfaces lends the architecture a unique and highly tactile flair.

#### Note

- **Interesting model of intergenerational housing with a variety of flexible living arrangements and a variety of shared spaces.**



←  
Go to  
contents

Site plan



←  
Go to  
contents

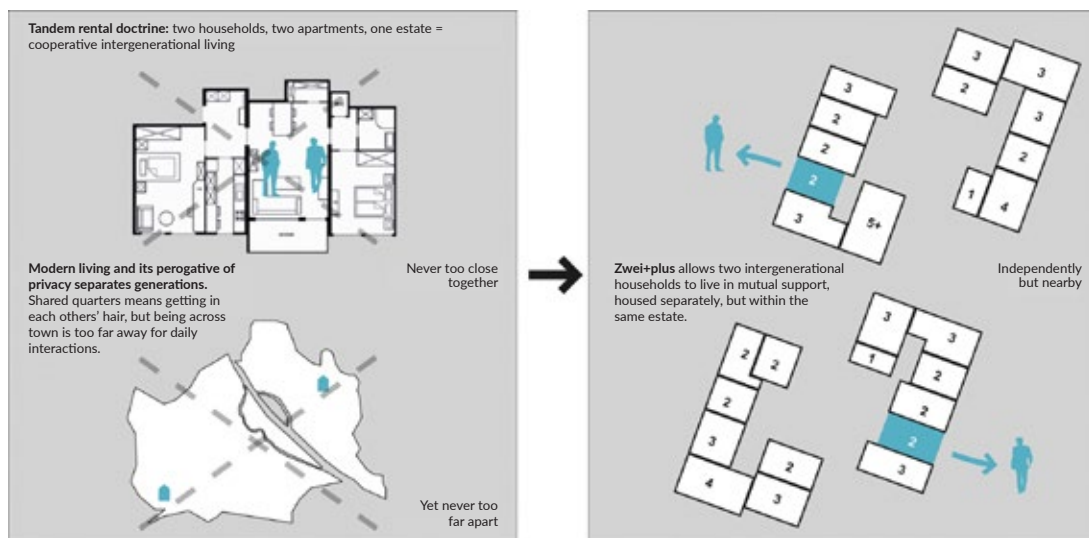
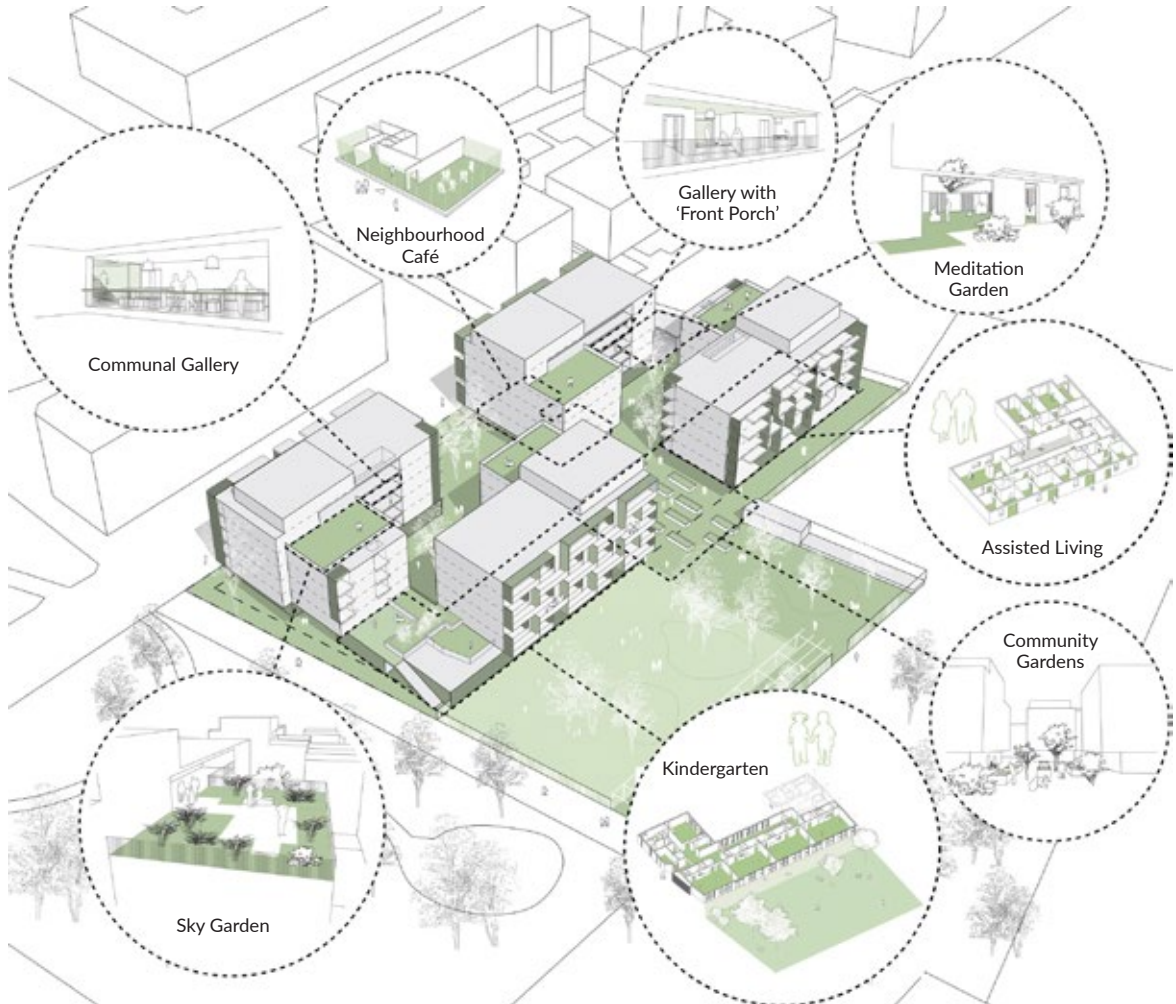

←  
Go to  
contents

Upper floor plan



© Trans-city TC



# Case study 13: Multifunctional building, rapid housing, Vienna

←  
Go to  
contents

## Rapid housing



### Location

Vienna, Austria



### Architect

trans\_city TC ZT



### Client

Kallinger Projekte

### Link

[trans-city.at/tc/portfolio/siemensstrasse/?lang=en](https://trans-city.at/tc/portfolio/siemensstrasse/?lang=en)

### Description<sup>19</sup>

IE/HOME 21 is a multifunctional building. It is also an ambitious social housing project. It is part of the City of Vienna's "Rapid Housing Program" (Sofortwohnbauprogramm), whose demanding requirements bring the project's diverse qualities together under one roof.

The Rapid Housing Program was a response to Vienna's housing crunch of 2015-2016. It subsidised

the pro tempore erection of housing upon underutilized, commercially-zoned, real estate. This housing could be composed of temporary, mobile constructions or be permanent buildings with fixed-term, rental housing occupancy. SIE/HOME 21 fits the latter category.

### Project details

**No. of dwellings:** 241

**Area:** Gross floor area 18.173 m  
Rentable residential floor area 11,928 m<sup>2</sup>  
Total rentable floor area 13,494 m<sup>2</sup>

**Construction:** Steel frame (slim building) and cast floor slabs

**Cost:** €16,193,000 – (€1,200/m<sup>2</sup> WNFL)

**Year:** 2018

19 Edited version of description provided on architect's website.



© Photo Daniel Hawelka

←  
Go to  
contents

Multifunctional building was therefore a prerequisite for this program. The buildings will provide the city with housing for the first 10 years of their life-cycle, but they must be designed so that they can be economically converted into commercial property after this initial period of usage.

This programmatic constraint required a simple, rapid, and use-neutral construction. SLIM-BUILDING® (Patent Dr Winfried Kallinger) answers these needs. This innovative system combines slim steel columns with cast-in-situ ferro-concrete floor slabs, generating open, non-directional spaces without cross-beams or load-bearing walls. Efficient construction is a prerequisite for rapid housing; Slim-Building reduces construction time for the building shell by half. Economy of time was also essential for the rentability of the undertaking. The project must be amortized within fifteen years, and therefore construction costs could not exceed €1,200/m<sup>2</sup>, which is approximately 20% less than similar housing estates using typical means of construction. These low building costs allow the rents to be set at surprisingly affordable rates: €7.50/m<sup>2</sup>, including maintenance, taxes and partial furnishings.

SIE/HOME 21 optimizes the potential of the SLIM BUILDING® system. The floor plans use a strict, highly-economical grid that functions ideally for both housing units and for future commercial use. The open spaces have ceiling heights of 2.82m and can be flexibly subdivided for a large variety of uses.

Compact yet well-organized apartments are to be rented to low-income tenants, many of whom are recent arrivals in Vienna. In the first floor of the north-west tract is a centre for single mothers; the ground floor of the southeast tract houses assisted living for the elderly. Many of the tenants are recovering from recent bouts of homelessness, and HOME 21 offers them their first apartment after years of living rough. The complex has no cellar and is not built-out below grade. At-grade parking complements the flexibly-subvisible commercial units on the ground floor.

The architectural language and the project's materials reflect the programme, building system and economy, and harmonizes the building's structure with the balconies, the façade and the ground floor usage. The frame of the balcony system is built out of galvanized steel tubes. Its verticals align with the axes of the SLIM BUILDING® system. The pre-cast balconies are laid upon horizontal consoles, which span between the verticals. The balconies can be placed upon the galvanized steel consoles in various positions. This generates a rhythmic counterpoint to the order of the structural grid. The play of colour between the red-rendered façade and the gold tones of the balconies lends the architecture both warmth and tension.

#### Note

- A structural system that provides flexibility so that it can be economically converted into commercial property after this initial period of usage.
- The buildings respond to the need for a temporary, rapid-response, economic form of housing that can be converted to other uses in a set time frame.

#### Upper floor plan

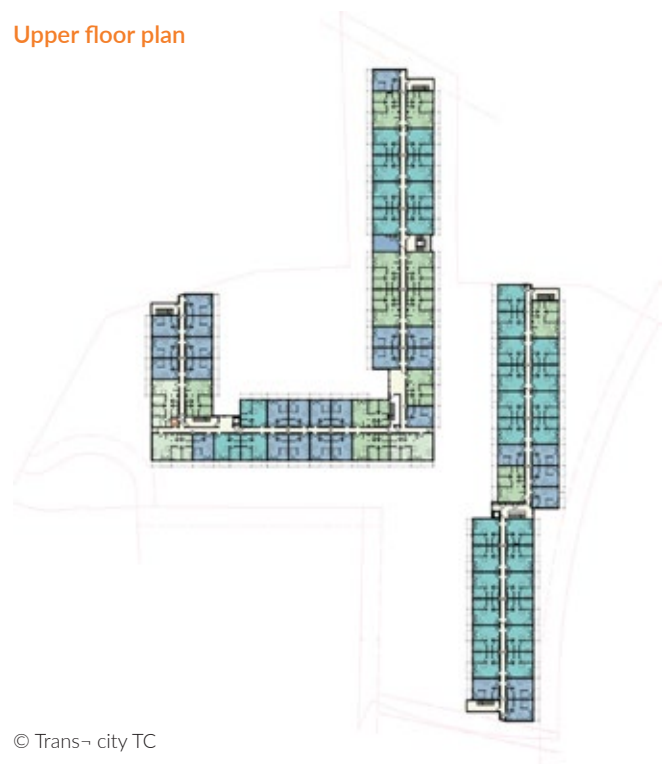

© Trans-city TC





© Trans-city TC



Ground floor

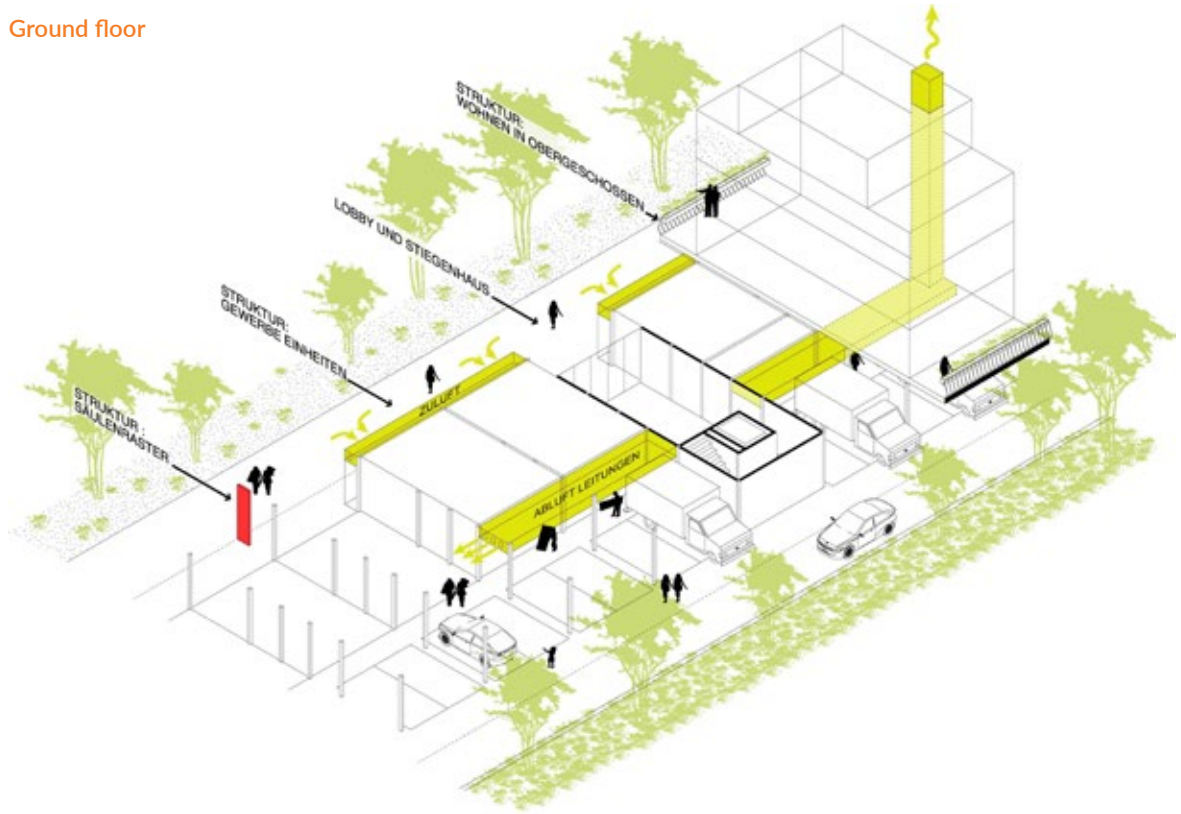

FLEXIBLE URBANISM THROUGH ADAPTABLE GROUND FLOOR

© Trans-city TC

# Case study 14: Community housing, Mautner-Markhof Gründe, Vienna



## Community orientated residential building



### Location

Wilhelm-Weber-Weg 1/3,  
1110 Wien, Österreich



### Architect

Tillner & Willinger



### Client

Österreichisches Siedlungswerk  
Gemeinnützige Wohnungsaktien-  
gesellschaft, Wien, Familienwohn-  
bau gemeinnützige Bau- und  
Siedlungsgesellschaft m.b.H., Wien

### Link

[www.tw-arch.at](http://www.tw-arch.at)

### Description<sup>20</sup>

“With us you get more than just an apartment.” This is the central message of the large community-oriented housing project in central Vienna.

<sup>20</sup> Description provided on architect's website.

Mautner-Markhof Gründe is a neighbourhood of 90 residential units in two distinct buildings, built in accordance with the high environmental standards of

### Project details

<b>No. of dwellings:</b>	91
<b>Area:</b>	11.500 m <sup>2</sup>
<b>Mix:</b>	74 subsidised rental and 17 senior housing units
<b>Procurement:</b>	Competition (2010)
<b>Energy performance:</b>	Passive House Standard
<b>Year:</b>	2014

© Photo Michael Nagl

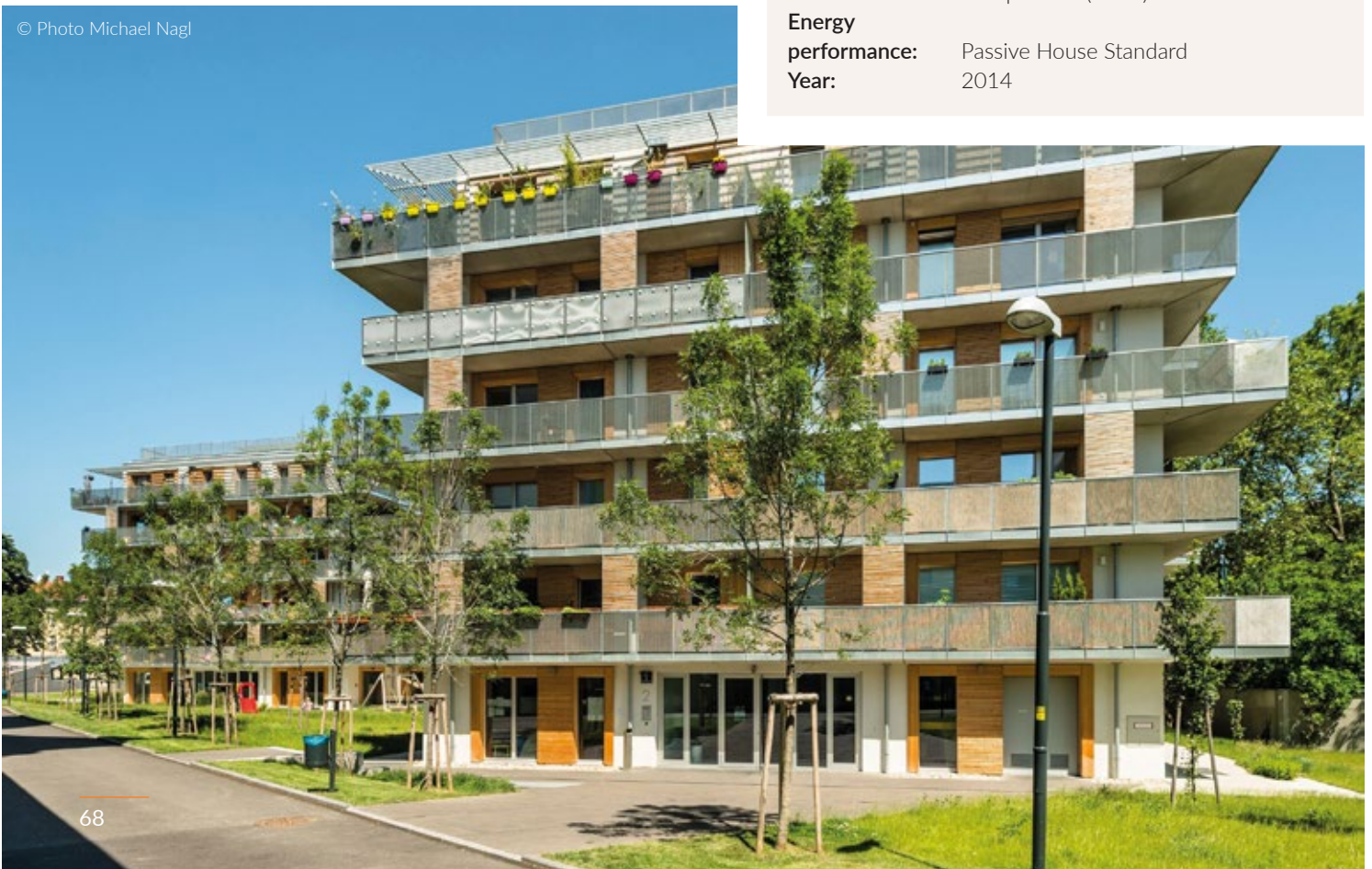

←  
Go to  
contents

the Passive House practice, including 74 subsidised rental apartments as well as senior housing units. The project aspires to foster a diverse community of different age groups and multicultural backgrounds living harmoniously together.

Fundamental to the design is the promotion of a community-based way of living and tolerance of other lifestyles and social values. Working with a sociologist to conduct an in-depth study of cultural demographics and different lifestyles, the architects designed a variety of configurable floor plan types from which residents can choose and freely adapt according to the individual's desired specifications.

A flexible structural framework and the resident's participation ensures sustainability throughout the building's tenant life-cycle.

Wrapping the building are continuous bands of loggias and projecting balconies, which expand unit

living rooms and serve to underscore each building's character as a kind of open pavilion.

The two apartment buildings each have spacious ground floors with communal areas that extend to the playful outdoor landscape, all of which reinforces the neighbourhood appeal. In addition, each building has a green roof – accessible by all the residents – complete with terraces, planting beds and communal winter gardens.

Strengthening the distinct character of each building are the contemporary paintings by artist Herbert Pasiiecznyk that fill the bright stairwells.

#### Note

- **The focus on creating a diverse community and with providing a flexible structural framework that allows future residents choice in the layout and the ability to adapt their home to meet future needs.**



# 4 / France



Social, co-operative, and affordable housing in France	71
Case study 15: Maréchal Fayolle housing, 16th Ar., Paris	73
Case study 16: Infill social housing, Paris	76
Case study 17: Infill social housing, Belleville, Paris	79
Case Study 18: Mixed use building with social housing, Paris	83
Case study 19: Social housing, Argenton Sur Creuse	87
Case study 20: Prefabricated social housing, Nogent-le-Retou	89
Case study 21: Suburban housing, Ivry-sur-Seine	92
Case study 22: Renovated and extended building, Tourcoing	96



# Social, co-operative, and affordable housing in France



**Population**  
65,273,511  
(mid 2020)



**Dwellings**  
28,077,000



**Tenure<sup>21</sup>**  
Social rent: 17.4%  
Private rent: 21.9%  
Owner occupier: 57.7%  
Other: 3%



**Housing providers<sup>21</sup>**  
State, municipal,  
local authorities and  
housing associations

France has a long history of providing subsidised social housing options to low-income citizens. Beginning in the late-19th century, the first public housing initiatives were privately funded by charitable donations. The early to mid-20th century saw a significant expansion of social housing and a shift toward state control of the housing market. The lack of construction during two World Wars, combined with a widespread rural exodus, led to skyrocketing rents that left many French families without affordable options.

Of the 14.5 million houses in France at the end of the war, half had no running water, three quarters had no indoor toilets, and 90 percent were without bathrooms. A significant portion of the population lived in unhealthy conditions in former military barracks, war-damaged buildings, and overcrowded slums.

The social housing system came to be known as the HLM, “habitations à loyer modéré,” which translates to “moderate rent habitations.” HLM continued to grow as immigrants from former French colonies arrived in Paris in the 1950s.

France’s “grands ensembles” – high-rise housing estates built between the 1950s and 1970s – were inspired by the functionalist architecture of the Swiss-French architect Le Corbusier.

A landmark 2000 law – known as the loi solidarité et renouvellement urbain (Solidarity and Urban Renewal Law) requires that cities set aside at least 20 percent of local housing as public housing.

In France, public housing is a public utility service for which the Government determines the major public policies and provides funding. For decentralisation purposes, the Government may delegate its authority to a public local body.

The rights and duties relating to carrying out this public service function are defined by law. Social housing units charge moderate rents and are granted to tenants on low incomes, equal to or less than specific limits. Should the income of a tenant increase over time and exceed such limits, he or she will be entitled to remain in the social flat.

There are 732 public and private social companies and associations that offer social housing throughout France. These operators manage 4.6 million social housing units, around 17% of French people’s primary residences. More than 12 million people live in social housing.

Currently, nearly 24% of the 1,160,000 primary residences in Paris are public housing units. The

Nearly **24%** of the 1,160,000 primary residences in Paris are public housing units

**732** public and private social companies and associations offer social housing in France

More than **12** million people live in social housing

21 Karausevc, Paul and Batchelor, Abigail: Social Housing Definitions and Design Examples, RIBA Publishing (2017).

←  
Go to  
contents

demand for public housing in Paris exceeds availability. In response to the increasing demand, the City of Paris has defined as a political priority the production of 7,500 social housing units per year. A 2013 law increased the requirement to 25% and Paris aims to reach this before 2025, as with every other French city with over 3,500 inhabitants. But, Anne Hidalgo, Mayor of Paris, and the City Council have decided that social housing should aim to be 30% of all Paris residences by 2030.

### Points of special interest

- That binding targets for local public housing can act as an effective driver for delivery.
- That social housing can play a significant positive role in the social, physical, and economic regeneration of cities, towns, and villages.
- That social housing projects have the potential to support innovation in housing design and construction.
- The importance of having a variety of social housing solutions, appropriate for their location and social context.
- The value of the architectural competition system as a source of innovative thinking and as a way of enabling young practices to obtain work.

### References

Paris Habitat: [www.parishabitat.fr/Pages/Anglais-About-us.aspx](http://www.parishabitat.fr/Pages/Anglais-About-us.aspx) (accessed October 2020).

European Commission: [ec.europa.eu/commission/presscorner/detail/en/IP\\_20\\_511](http://ec.europa.eu/commission/presscorner/detail/en/IP_20_511) (accessed October 2020).

Architizer:Architectural Projects: [architizer.com/projects/q/type:residential,multi-unit-housing/location\\_auto:Paris,+France](http://architizer.com/projects/q/type:residential,multi-unit-housing/location_auto:Paris,+France) (accessed October 2020).

# Case study 15: Maréchal Fayolle housing complex, 16th Ar., Paris

←  
Go to  
contents

## Social housing



### Location

Ave. Maréchal Fayolle,  
16th Ar., Paris, France



### Architects

Kazuyo Sejima and Ryue  
Nishizawa of SANAA (Design  
Architect) & Extra Muros  
(Local Executive Architect)



### Client

Paris Habitat

### Links

[www.sanaa.co.jp](http://www.sanaa.co.jp)

[worldarchitecture.org/article-links/eemff/sanaa-social-housing-complex-composed-of-organic-forms-in-paris-photographed-by-vincent-hecht.html](http://worldarchitecture.org/article-links/eemff/sanaa-social-housing-complex-composed-of-organic-forms-in-paris-photographed-by-vincent-hecht.html)

[www.archdaily.com/936122/apartments-on-ave-marechal-fayolle-sanaa](http://www.archdaily.com/936122/apartments-on-ave-marechal-fayolle-sanaa)

### Description<sup>22</sup>

Designed by the Japanese architectural practice SANAA and located in Paris's 16th arrondissement, the Maréchal Fayolle Housing Complex is a far cry from traditional public housing. The complex is made up of

### Project details

<b>No. of dwellings:</b>	100 apartments in four irregularly shaped towers, which contain anywhere from 12 to 48 apartments
<b>Area:</b>	2,127 m <sup>2</sup>
<b>Procurement:</b>	Competition
<b>Construction:</b>	Concrete
<b>Car spaces:</b>	103
<b>Year:</b>	2019

<sup>22</sup> Edited version of descriptions provided in [worldarchitecture.org](http://worldarchitecture.org) and [archdaily.com](http://archdaily.com).

© Photo SANAA



←  
Go to  
contents

four irregularly shaped towers, which contain anywhere from 12 to 48 apartments. The five-storey buildings fit with the surroundings and do not tower over the adjacent neighbourhood.

Floor plans range from studios to four-bedroom apartments, offering homes that will work for young professionals and families alike. The project was designed for Paris Habitat, a public utility company that manages 124,000 social housing units in and around Paris.

The project is situated in the 16th district of Paris, surrounded by classic Haussmann urbanism on one side and the Bois de Boulogne on the other. The four housing volumes weave past each other creating a sequence of courtyards that connect city and landscape, bringing a series of interstitial gardens to the heart of the site.

The design is characterized by its organic forms and the curved façades provide apartments with multiple orientations for natural light, ventilation and views. This creates transparency across the site, opens views towards the park and provides breaks in the continuity of the street. The ground level pilot space is punctuated by a series of expanded metal bubbles that house the entrances and bike storage and reception areas, while a softly undulating landscape buffers each of the buildings at ground floor level.

#### Note

- **These very beautiful building forms, located at the interface between the Haussmannian architecture of the 16th Arrondissement and the Bois de Boulogne, respond sensitively to their location.**



© Photo SANAA

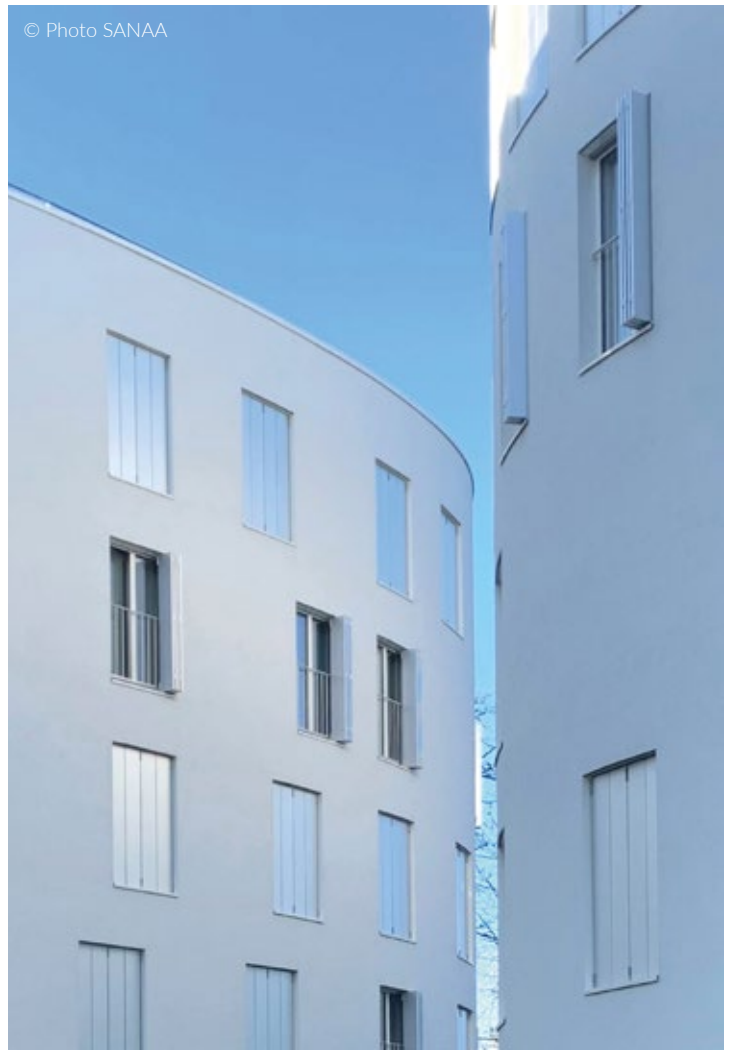

# Case study 16: Infill social housing, Paris



## Social housing



### Location

Avenue Netter, Paris,  
France



### Architect

FRES Architectes

### Links

[www.fres.fr](http://www.fres.fr)

[divisare.com/projects/375355-fres-architectes-netter-social-housing](https://divisare.com/projects/375355-fres-architectes-netter-social-housing)

23 Edited version of architect's description provided in [Divisaire.com](https://divisaire.com).

### Description<sup>23</sup>

"How to build in a contemporary way and at the same time in the historical continuity of Paris? How to build in a district of Paris with a strong Haussmannian identity and at the same time how to answer the challenges of nowadays, and among them sustainability?"

### Project details

**No. of dwellings:** 12

**Mix:** 9 dwellings – 3 studios, 4 no. 2 bedroom apartments and 2 no. 3 bedroom apartments (all social)

**Construction:** Pre-fabricated concrete façade

**Energy performance:** The building is highly insulated with a very effective thermal skin, with an energy supply of 40 Watt/m<sup>2</sup>/year and an air-proof skin of 0,20 m<sup>3</sup>/m<sup>2</sup>.h which is similar to Passiv Haus certification

**Year:** 2017

© Photo Philippe Ruault, FRES architectes





© Photo Philippe Ruault, FRES architectes

The organisation of the dwellings inspires itself from Haussmannian apartment principles, with living spaces oriented towards the street, and bedrooms towards the courtyard. All the apartments, except the studios, are dual aspect.

The typologies are organised around a service-core that accesses the bathroom, toilets, and kitchen. In some of the dwellings, one can walk all around this core. The façades develop themes of the Parisian architecture such as its composition and materiality.

**Note**

- Example of an efficient infill social housing development that replicates Haussmannian architecture, with living spaces facing the busy street, a central service core, and bedrooms at the (quieter) back of the building.

© Photo Philippe Ruault, FRES architectes





Ground floor plan



© FRES architectes

Upper floor plan



© FRES architectes

7th (top) floor plan



© FRES architectes



# Case study 17: Infill social housing, Belleville, Paris

←  
Go to  
contents

## Social housing



### Location

Belleville Street, Paris,  
France



### Architect

Atelier Du Pont



### Client

Elogie-Siemp

### Links

[www.atelierdupont.fr](http://www.atelierdupont.fr)

[www.archdaily.com/904837/social-housing-in-belleville-street-atelier-du-pont](http://www.archdaily.com/904837/social-housing-in-belleville-street-atelier-du-pont)

[divisare.com/projects/397525-atelier-du-pont-takuji-shimmura-social-housing-belleville-street](http://divisare.com/projects/397525-atelier-du-pont-takuji-shimmura-social-housing-belleville-street)

### Description<sup>24</sup>

The project is composed of 2 buildings hosting 19 social housing units, and a shop on the ground floor. The urban fabric of Belleville is composed of two intersecting systems: on the one hand narrow busy roads lined with typical “faubourg”-style apartment buildings cascading down the hill; and on the other the spaces at the centres of the city blocks, which are very

<sup>24</sup> Edited version of architect's description provided in Divisaire.com.

### Project details

No. of dwellings:	19
Area:	1,257 m <sup>2</sup>
Year:	2018

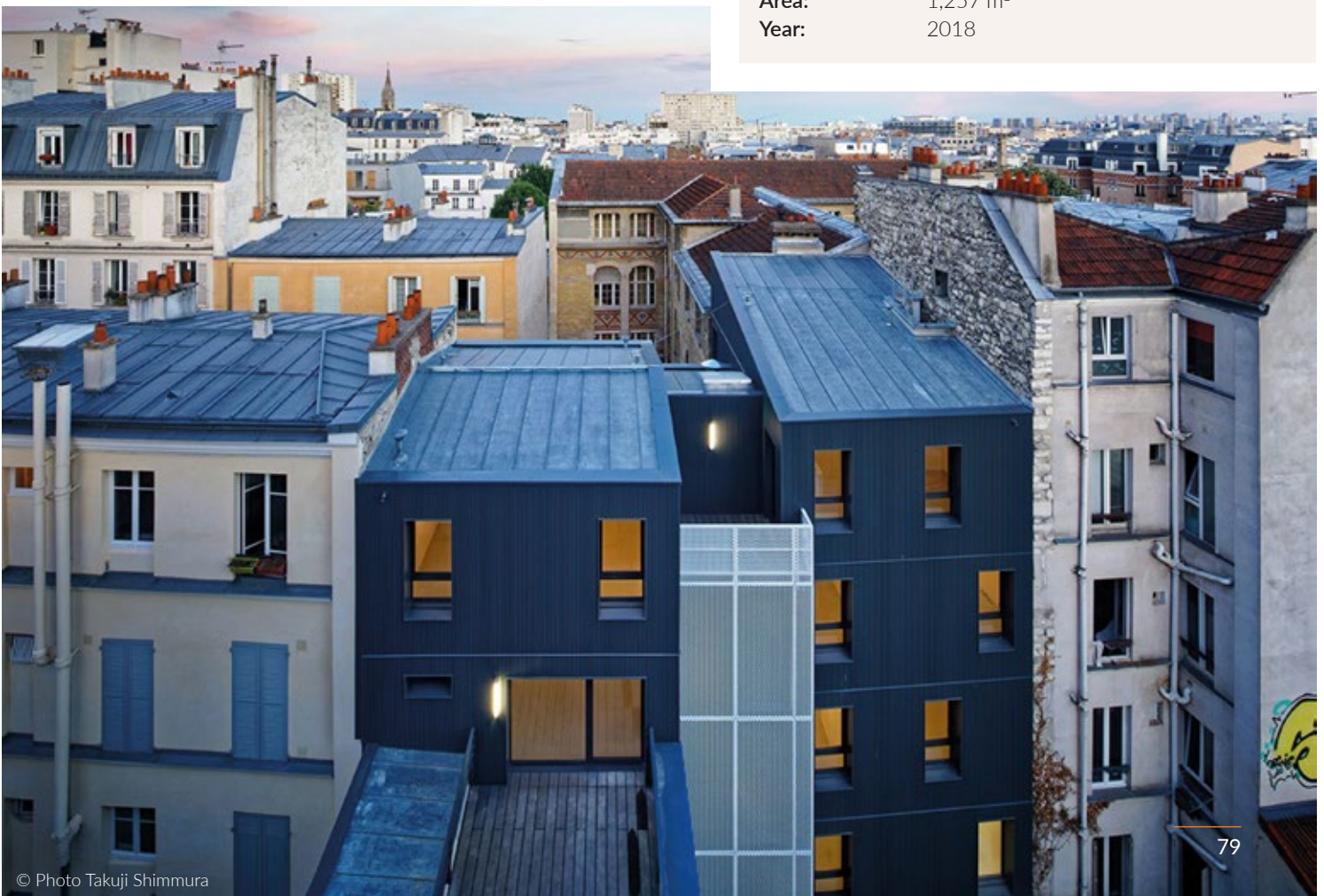



narrow, often planted, and lined with vernacular buildings running perpendicular to the slope.

The project aims to be a contemporary design revisiting the traditional faubourg housing type.

The heart of the block is a green alley that harmonizes with the existing fabric and reveals the depth of the plot. Box-balconies stretch from the façade to offer

generous outdoor spaces and wide and unobstructed views of Paris.

**Note**

- A modern intervention with density achieved through clever use of a typical Parisian urban plot.

**Section**



© Atelier Du Pont

© Photo Takuji Shimmura



© Photo Takuji Shimmura



© Photo Takuji Shimmura





### Ground floor plan



© Atelier Du Pont

### Upper floor plan



© Atelier Du Pont

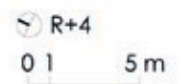

# Case study 18: Mixed use building with social housing, Paris

←  
Go to  
contents

## Patronage Laique & social housing



### Location

Corner of Avenue Felix Faure and Rue Tisserand, 15th Ar., Paris, France



### Architects

LAPS Architecture & MAB Arquitectura



### Client

RIVP Régie immobilière de la Ville de Paris

### Links

[www.lapsarchitecture.com/patronage-laique](http://www.lapsarchitecture.com/patronage-laique)

[www.mabarquitectura.com](http://www.mabarquitectura.com)

[www.archdaily.com/602384/patronage-laique-and-social-housing-laps-architecture-mab-arquitectura](http://www.archdaily.com/602384/patronage-laique-and-social-housing-laps-architecture-mab-arquitectura)

### Project details

**No. of dwellings:** 30 studio apartments for young workers

**Area:** 1,500 m<sup>2</sup> ERP + 1,380 m<sup>2</sup> housing

**Mix:** Mixed use building with housing for young workers and offices for Patronage Laique

**Procurement:** Competition

**Energy performance:** Plan climat Ville de Paris, H&E profil A, BBC Effnergie, Qualitel

**Year:** 2014

© Photo Luc Boegly

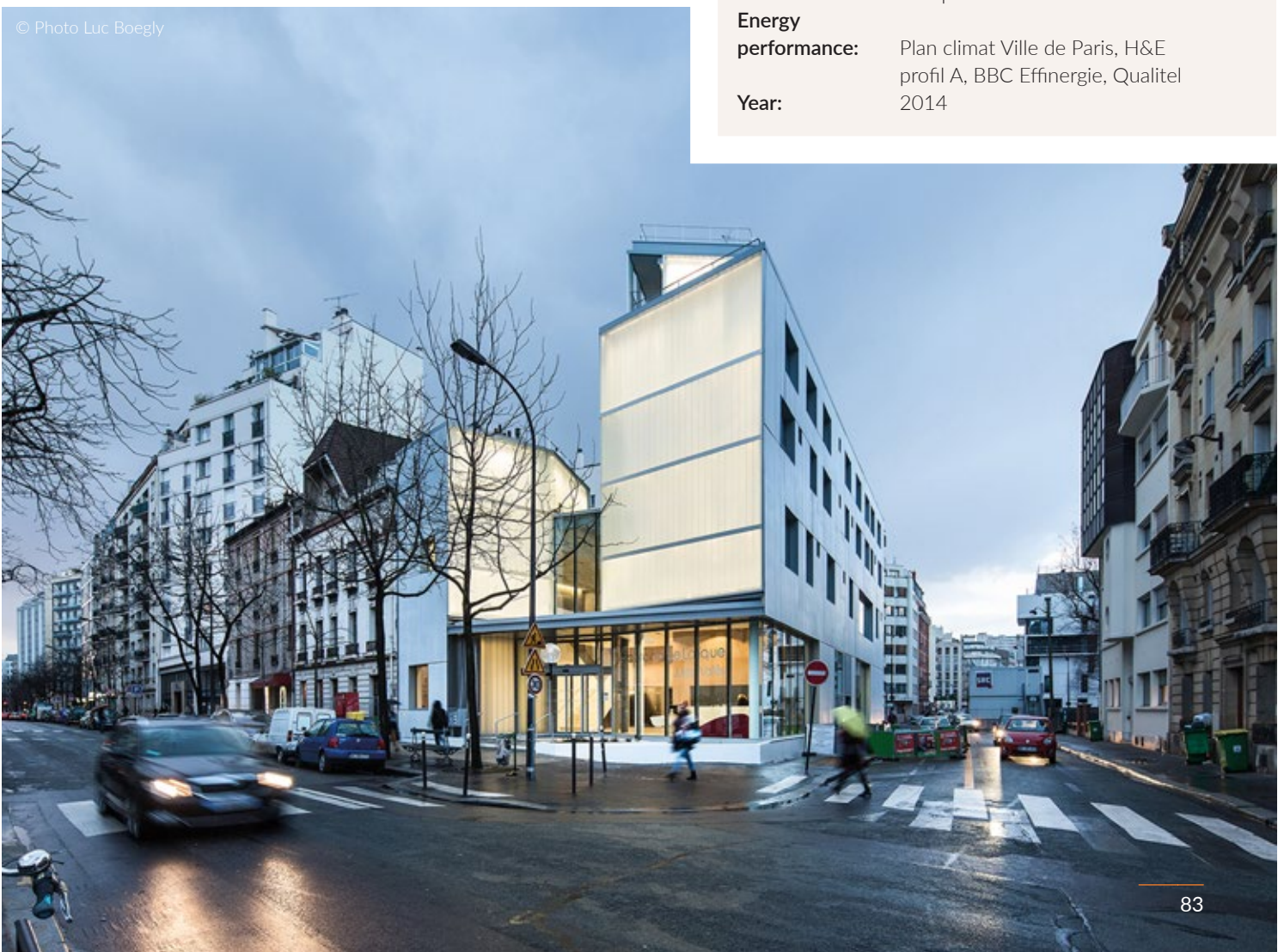



### Description<sup>25</sup>

The RIVP called for a design competition for a new building that was to house not just the original Laique program but also 30 studio apartments for young workers. The competition was won by a team composed of two young architecture firms, MAB and LAPS. Their holistic approach highlighted the relationship between the city and public space.

The proposition fosters user-friendliness by creating generous meeting places and favouring an opening onto the city.

The public facility and the housing enjoy two distinct entrances. The Patronage opens wide onto Avenue Felix Faure and rises one storey from the ground floor. Its glassed-in atrium extends the public space within the building while enabling neighbours and the

passers-by to glimpse activities happening in the building. The residence has a more discrete side entrance on Rue Tisserand and extends from the second storey to the fifth.

A corner café anchors the facility to the ground and the neighbourhood.

Light is one of the project's key components. At night time the back-lit façades of the building's prow make the facility look like a magic lantern. The building is a hallmark for the neighbourhood and a benchmark on the avenue.

### Note

- **Two programmes well integrated into one building envelope and making a significant contribution to the urban landscape.**



25 Edited version of architect's description provided on architects' websites and in [archdaily.com](https://www.archdaily.com).

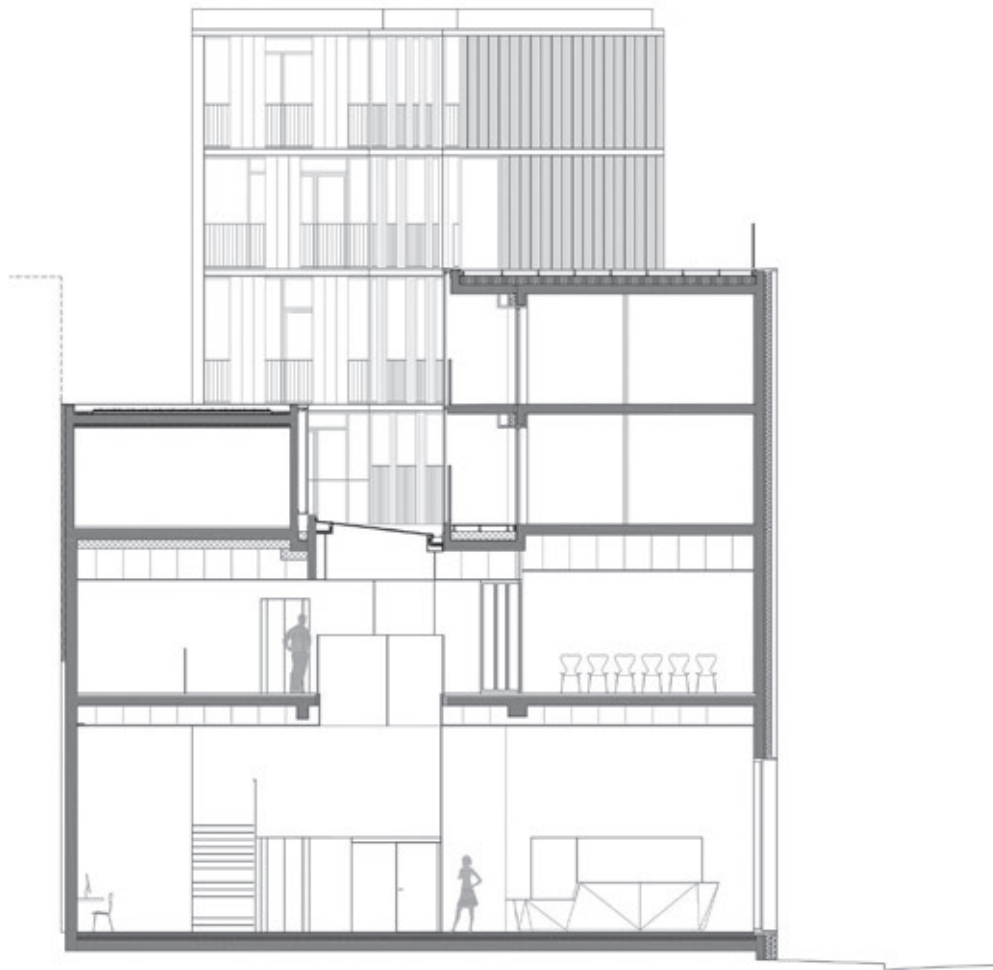

Section 0 1 5 10

© LAPS Architecture + MAB Architectura

←  
Go to  
contents

### Second floor plan

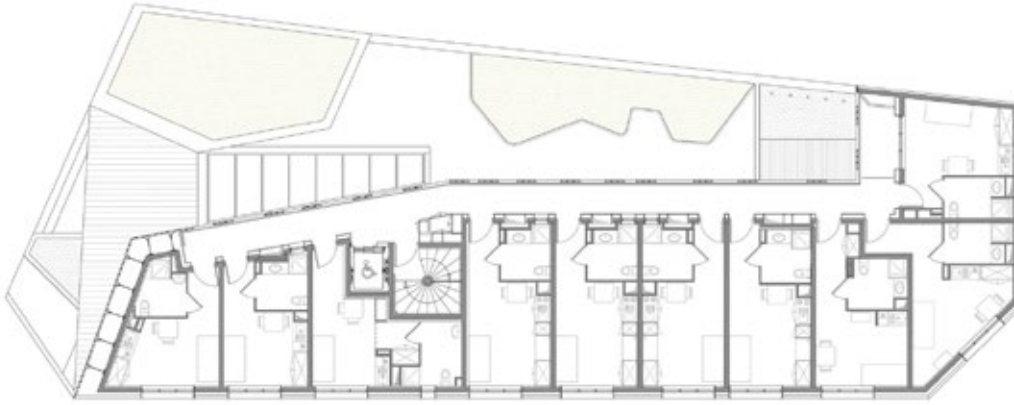

© LAPS Architecture + MAB Architectura



### Fourth floor plan

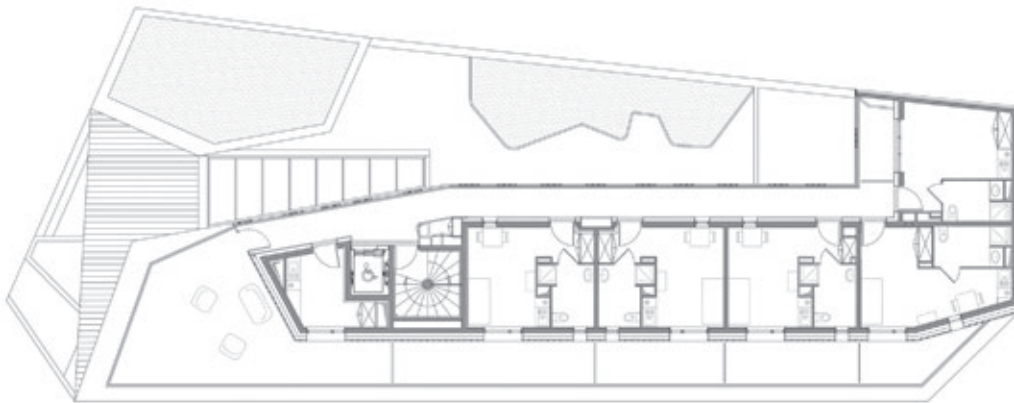

© LAPS Architecture + MAB Architectura

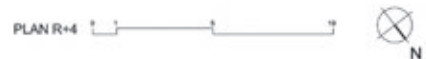



# Case study 19: Social housing, Argenton Sur Creuse



## Social housing



### Location

Argenton Sur Creuse,  
France



### Architect

Atelier Alassoeur

### Project details

**No. of dwellings:** 24

**Area:** Total area 1,614 sqm

**Construction:** Concrete with timber cladding  
and coloured steel

**Car spaces:** 26 spaces

**Year:** 2013

### Links

[www.atelier-allassoeur.com](http://www.atelier-allassoeur.com)

[www.archdaily.com/514037/24-housings-in-argenton-sur-creus-atelier-allassoeur](http://www.archdaily.com/514037/24-housings-in-argenton-sur-creus-atelier-allassoeur)

### Description<sup>26</sup>

The housing is in the centre of Argenton sur Creuse, a small, picturesque town in central France.

The housing is located in close proximity to the library and fits into a plot of rough ground. A gradient of more than thirteen metres separates the highest and lowest points of the site.

Four blocks are spread out over the site. The first, bordering the street, marks the entrance and frames the retained existing building. The other

<sup>26</sup> Edited version of description provided on architect's website.

© Photo Brice Desrez





blocks are distributed around the peripheries of the site and extend onto two to four levels. Access is from the outside and is achieved through passageways.

The whole of the ground floor area is accessible and a lift serves the main building.

**Note**

- Interesting town infill of 24 apartments in four blocks on a fragmented, sloping site. Simple economic structures with deck access.

**Site plan**

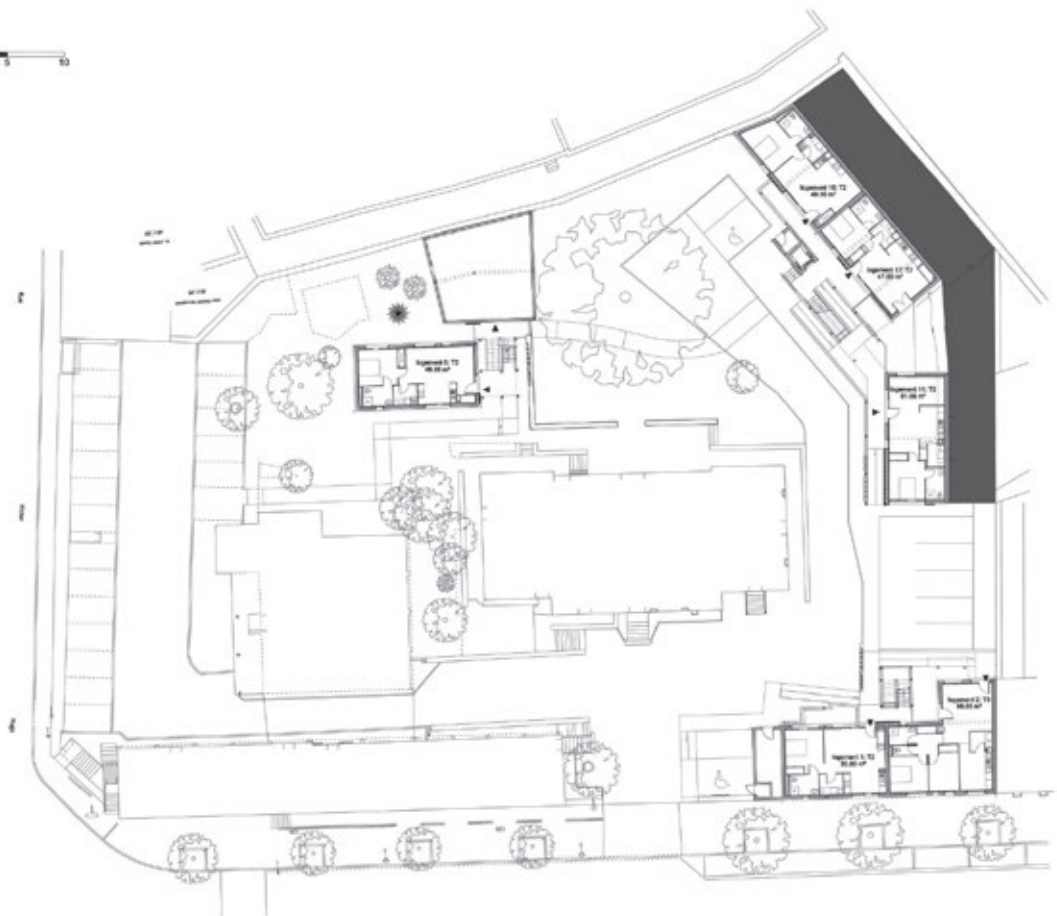

© Atelier Allassoeur

# Case study 20: Prefabricated sustainable social housing, Nogent-le-Retou



## Social housing



### Location

Nogent-le-Retou,  
Northern France



### Architect

NZI Architectes

### Links

[www.nzi.fr/logements-nogent](http://www.nzi.fr/logements-nogent)

[www.domusweb.it/en/architecture/gallery/2020/04/03/in-france-a-prefabricated-social-housing-is-built-with-straw-and-wood.html](http://www.domusweb.it/en/architecture/gallery/2020/04/03/in-france-a-prefabricated-social-housing-is-built-with-straw-and-wood.html)

[www.archdaily.com/918820/wood-and-straw-housing-nzi-architectes](http://www.archdaily.com/918820/wood-and-straw-housing-nzi-architectes)

### Project details

<b>Area:</b>	1,200 sqm
<b>Construction:</b>	Prefabricated straw panels with timber cladding
<b>Sustainability:</b>	Sustainable housing units in a park in Nogent-le-Rotrou using straw, a lightweight and high-performance material
<b>Year:</b>	2019

### Description<sup>27</sup>

The project by NZI Architectes of 13 wooden and straw houses for social housing, is located in Nogent-le-Rotrou, a small French town in the Loire Valley Centre region.

27 Edited version of description provided on architect's website and by Francesca Grilloo for Domus.





The residential complex is set in a large park in the Gauchetières district and is based on the principle of sustainability: the use of wood and straw as building materials allows for lightweight walls that can be lifted and moved easily and for the construction of large panels in the factory with on-site assembly.

The material is healthy, durable, and highly efficient. The houses, clad with wooden planks, are arranged in three lots consisting of 4 or 5 houses each – A, B and C, with the first and third ones mirrored, and the central one placed slightly behind the other two. The French studio used a fastening system that includes

a cut in the roofs so that the adjacent modules are “anchored” to each other.

70% of the envelope for this project was built in the workshop. The walls are wooden boxes that have been carefully filled with 36 cm thick bundles of compressed straw. Then these boxes were closed to receive the wooden cladding, all fixed in the workshop.

**Note**

- **Innovative, sustainable form of construction for social housing.**



© NZI Architectes



# Case study 21: Suburban social and collective housing, Ivry-sur-Seine

←  
Go to  
contents

## Social housing



### Location

94200 Ivry-sur-Seine,  
France



### Architect

Atelier du Pont

### Links

[www.atelierdupont.fr](http://www.atelierdupont.fr)

[www.archdaily.com/883652/social-housing-atelier-du-pont](http://www.archdaily.com/883652/social-housing-atelier-du-pont)

28 Edited version of architect's description provided in [archdaily.com](http://archdaily.com).

### Description<sup>28</sup>

Located in a Paris suburb, in a flood risk area, this project of 61 social housing units contributes to the objective of the Ivry Confluences Urban Development Zone (ZAC) to revitalize the southern part of this former industrial district.

To ensure a transition between the scales of the very different urban situations, the project forms a homogeneous built environment made up of a series of buildings ranging from two to seven storeys in height. This staggered height plan goes hand-in-hand with a consideration of the range of uses and typologies, urban forms and modes of living that form a city.

### Project details

**No. of dwellings:** 61  
**Area:** 4,100 sqm  
**Year:** 2017

© Photo Takuji Shimmura



←  
Go to  
contents

The buildings on the street corner are collective housing and have a far-ranging view out over the neighbourhood, but the height then gradually tails off towards the small square on the south side, splitting up to form an intermediary environment of superimposed townhouses. This typology marries the need for compactness with the quality of individual homes or small-scale collective housing that reflect the neighbourhood's past and how people have always lived there.

The houses and flats are raised above ground level since the site is covered by flood prevention regulations. They are reached by means of a pathway

that passes through the treetops of a ground-level park, offering residents a gentle transition between private, collective, and public spaces along with a view of the entire site.

Artistic add-on, Atelier YokYok, painted an anamorphosis on the porches, establishing a graphic and playful dialogue with the architecture and the nearby school group.

#### Note

- Compact development with a variety of housing typologies.



© Atelier du Pont

© Photo Takuji Shimmura



© Photo Takuji Shimmura

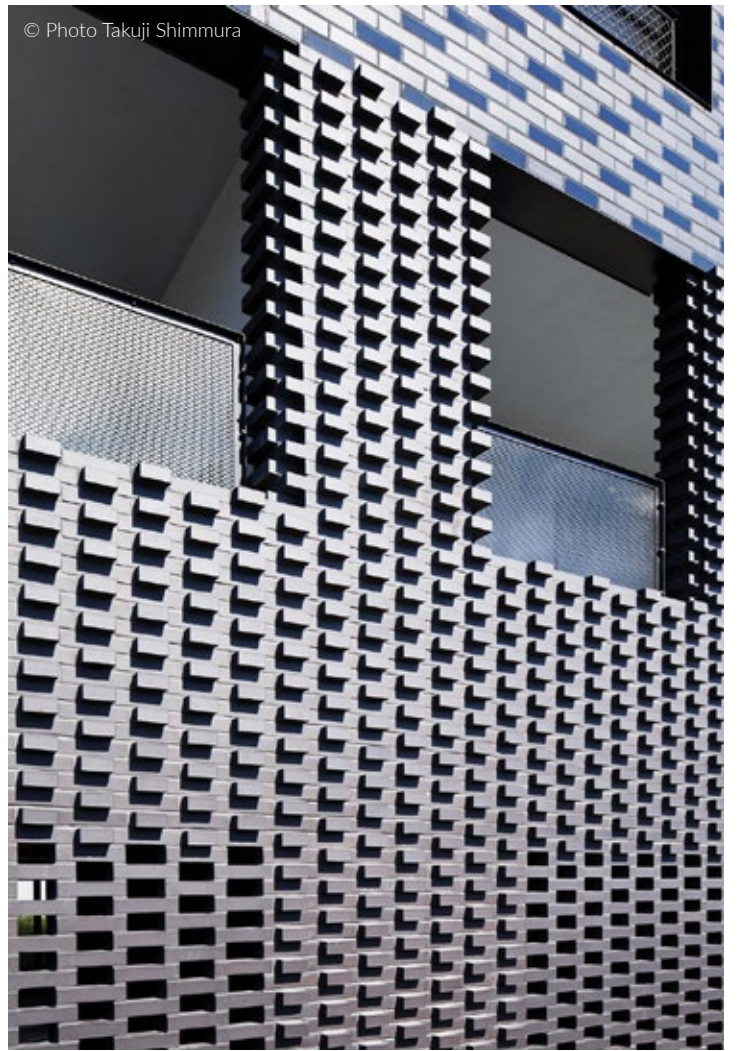

© Photo Takuji Shimmura

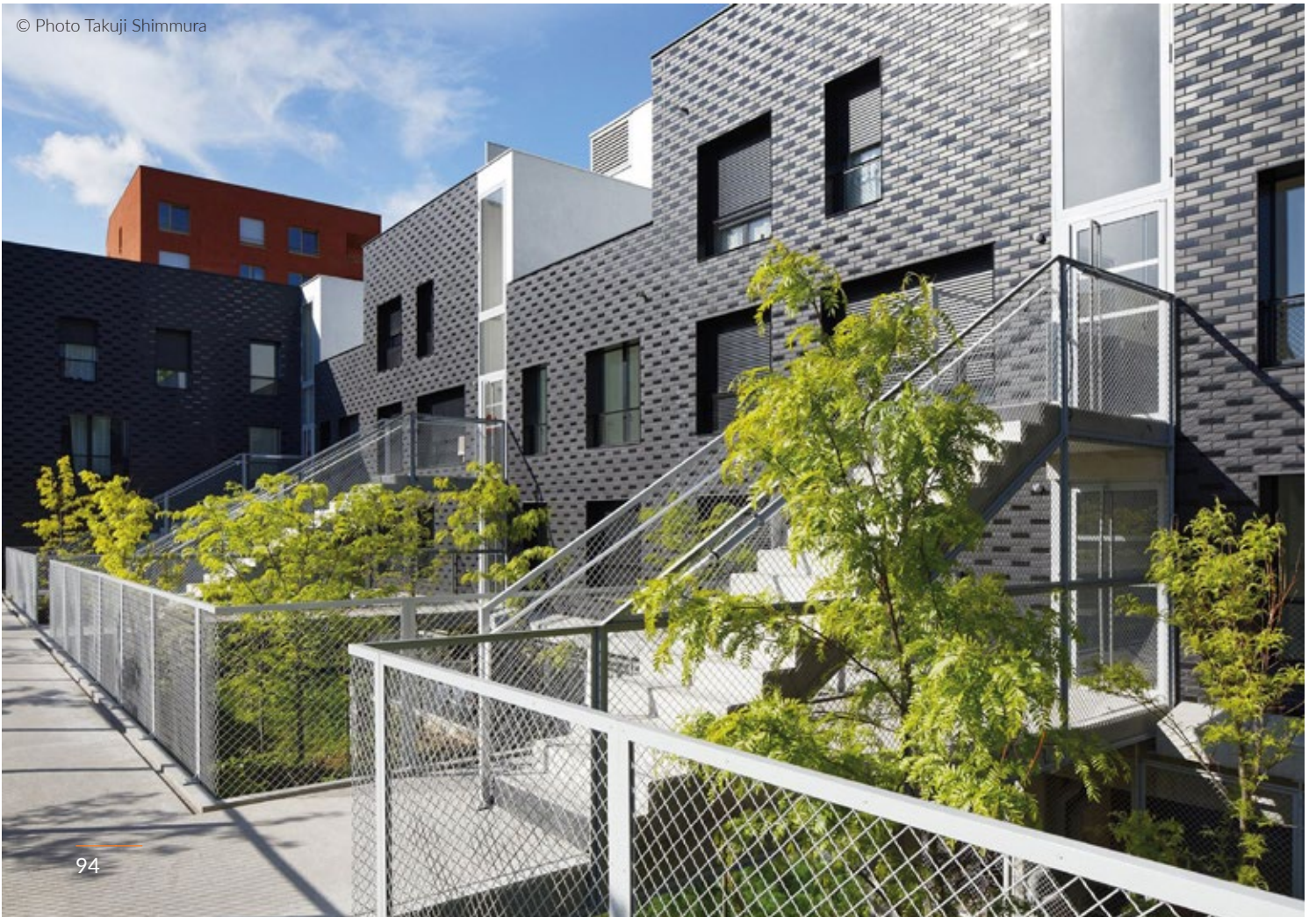



←  
Go to  
contents



Floor plans

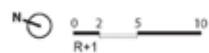

# Case study 22: Renovated and extended landmark building, Tourcoing



## Social housing



### Location

Avenue de la Marne, Tourcoing, Northern France



### Architect

D'HOUNDT+BAJART Architectes and Associés

### Project details

**No. of dwellings:** 8  
**Area:** 595 m<sup>2</sup>  
**Construction:** Timber frame  
**Year:** 2019

### Links

[www.dhoundtplusbajart.fr/VILLA-MAILLARD-2](http://www.dhoundtplusbajart.fr/VILLA-MAILLARD-2)

[www.archdaily.com/935587/villa-maillard-dhoundt-plus-bajart-architectes-and-associés](http://www.archdaily.com/935587/villa-maillard-dhoundt-plus-bajart-architectes-and-associés)

[archello.com/project/villa-maillard](http://archello.com/project/villa-maillard)

### Description<sup>29</sup>

Named after its architect, the Villa Maillard is a landmark 1930s building on Avenue de la Marne heading into the city of Tourcoing. Uncared for and neglected for a long time, the Villa Maillard is now fully renovated and expanded to host eight social housing units in the heart of a splendid garden. The careful renovation pays great attention to the existing architectural details.

<sup>29</sup> Edited version of architect's description provided in [archello.com](http://archello.com) and [archdaily.com](http://archdaily.com).

© Photo Philippe Braquenie, LDK Laurent Dequick, Maxime Naveteur



←  
Go to  
contents

Subject to image requirements at the town entrance, this project offers its residents an outstanding living environment in a somewhat gentrified neighbourhood. The housing units are bright with unconventional volumes, the common portions are well designed, and the private gardens match the expectations of one of France's greatest tree-lined avenues.

Beyond its architecture, another feature of the Villa Maillard lies in its park planted with remarkable

specimens and especially a ginkgo biloba tree. Those trees are listed as part of the local heritage, while the house is not. The extension is lined with stylish ginkgo leaves.

#### Note

- **Landmark dwelling in a listed garden converted and extended to provide social housing.**

#### Ground floor plan



© D'HOUNDT+BAJART Architectes and associés

# 5 / Germany

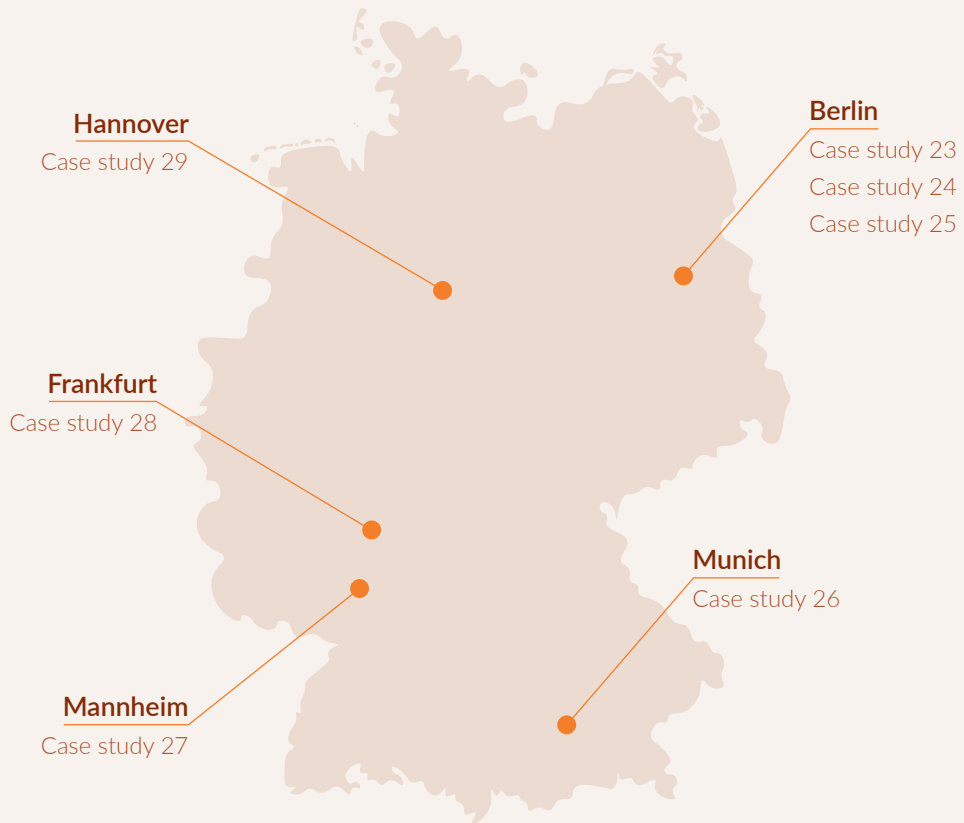

Social, co-operative, and affordable housing in Germany	99
Case study 23: Residential and studio building, Berlin	100
Case study 24: Co-operative housing, River Spreefeld, Berlin	106
Case study 25: R50 – cohousing, Berlin	111
Case study 26: wagnisART co-operative housing, Munich	115
Case study 27: Masterplan, Traumhaus Funari, Mannheim	120
Case study 28: Affordable housing, Frankfurt	124
Case study 29: Micro-apartments, Georgengarten, Hannover	127

# Social, co-operative, and affordable housing in Germany



**Population**  
83,020,000  
(2019)



**Dwellings**  
40,545,000



**Tenure<sup>30</sup>**  
Social rent: 4.2%  
Private rent: 50.4%  
Owner occupier: 45.4%



**Housing providers**  
All market players – municipal or private housing companies, co-operatives, or private investors can access credit/subsidies to provide social housing

In Germany the term 'social housing' is rarely used and legal texts generally refer to 'publicly subsidised housing' or 'housing promotion', which represents about 5% of the national housing stock. Today public intervention in housing policy in Germany is not linked to specific providers, but entails public subsidy of any kind of housing providers in exchange for the use of a dwelling for social purposes (enforcing income ceilings and lower rents) on a temporary basis. It should be noted that social housing is, since 2006, entirely a competence of the Lander (provinces), which have implemented different programmes and funding schemes. Local authorities are responsible for ensuring affordable accommodation for those unable to secure adequate housing themselves, while the federal state remains responsible for housing allowances to individual households and rent regulation.<sup>31</sup>

The institutional non-profit sector was dissolved in 1989, and at the same time extensive assets owned by municipalities were transferred to private market-oriented owners. Today providers of publicly subsidised housing include municipal housing companies and co-operatives (which constitute the traditional non-profit sector) as well as private landlords, commercial developers and investors with

a variety of shareholders. From a legal point of view, all housing companies are considered market actors, although municipal housing companies act according to local policies and housing needs.

## Points of special interest

- The commitment in Germany to creating inclusive and integrated communities and how that influences design – for example in deck access that also acts as community space, and in the application of universal/barrier free design standards.
- The participation by the residents in the design process and frequently providing residents with the freedom to fit out their own apartments.
- The inclusion in many of the schemes of facilities that can be used by the wider community.
- The widespread use of pre-fabrication as a way of achieving affordable housing.
- The in-built flexibility provided to allow for future changes of use.

30 Karausevc, Paul and Batchelor, Abigail: Social Housing Definitions and Design Examples, RIBA Publishing (2017).

31 Housing Europe: [www.housingeurope.eu/section-15/resources-articles?topic=research](http://www.housingeurope.eu/section-15/resources-articles?topic=research) (accessed October 2020).

# Case study 23: Residential and studio building at the former Berlin flower market, Berlin

Mixed tenure and use housing (a quarter at sustainable low rent)

←  
Go to  
contents



## Location

Berlin, Germany



## Architects

ifau & Heide & von Beckerath



## Client

BeB, GbR

## Links

[www.ifau.berlin/projects/ibeb](http://www.ifau.berlin/projects/ibeb)

[heidevonbeckerath.com/single/r50-cohousing](http://heidevonbeckerath.com/single/r50-cohousing)

[www.archdaily.com/941785/residential-and-studio-building-at-the-former-berlin-flower-market-ibeb-ifau-plus-heide-and-von-beckerath](http://www.archdaily.com/941785/residential-and-studio-building-at-the-former-berlin-flower-market-ibeb-ifau-plus-heide-and-von-beckerath)

## Project details

**No. of dwellings:** 66 apartments and 17 studios

**Area:** 12,264 m<sup>2</sup>

**Mix:** 66 apartments and 17 studios and 3 commercial units at ground level. 8 of the residential units provide supported-living facilities for people with disabilities

**Procurement:** Multi stage qualification process

**Energy**

**performance:** Efficiency House 70 (EnEV 2014)

**Year:** 2018

© Photo Andrew Alberts

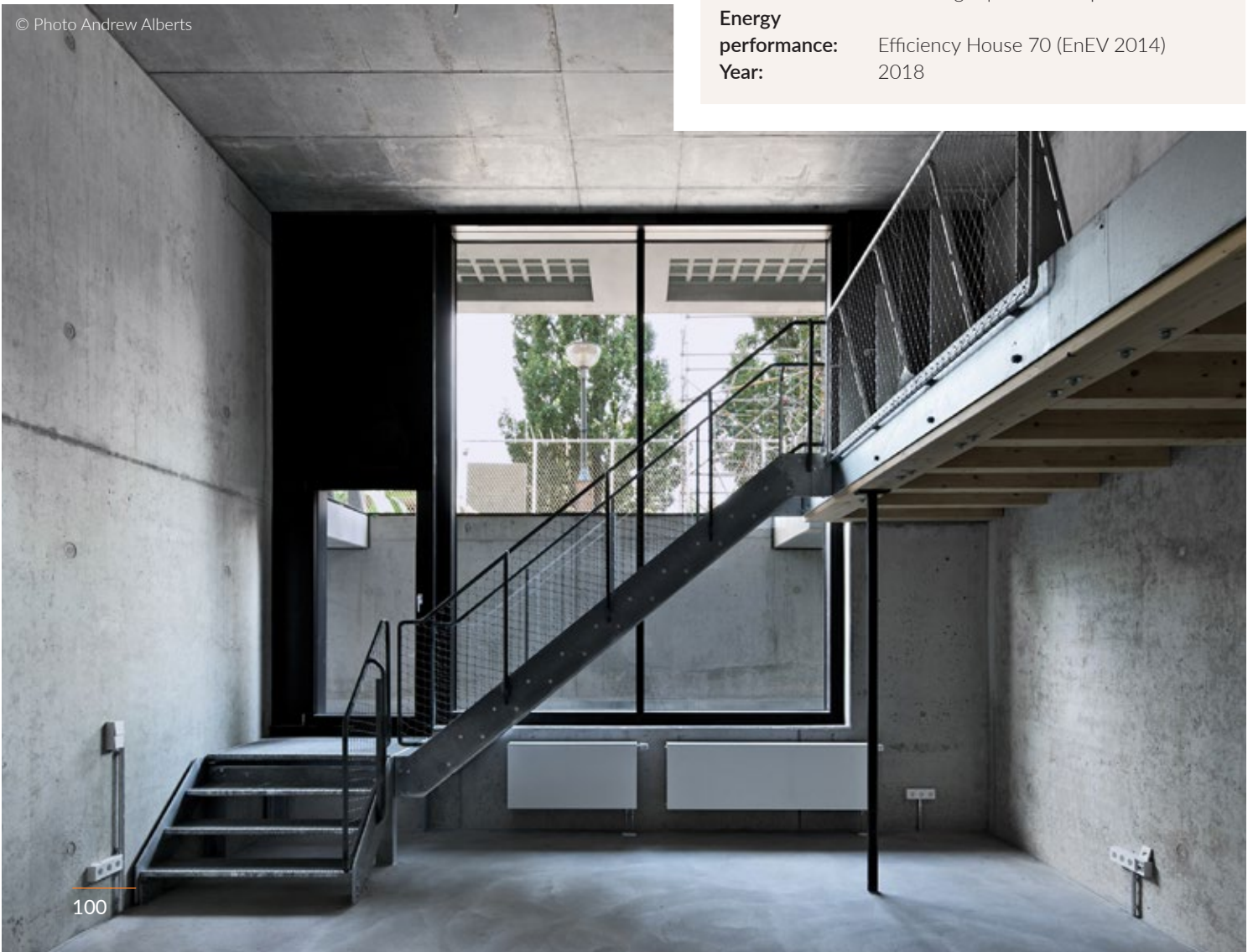

←  
Go to  
contents

### Description<sup>32</sup>

The former central flower market is situated in the historic Südliche Friedrichstadt in Berlin's Kreuzberg district. The actual market hall is used by the Academy of the Jewish Museum, which stands across the road.

The development objective for the plot south of the hall was to establish a diverse and mixed pattern of use for a wide spectrum of residents. Owner-occupied artists' studios and apartments, co-operative housing and studios, space provision for social associations, and commerce were part of the programme for the establishment of a new building group and hence lay the foundation for the IBeB. The main idea for the project, which was initiated by the architects ifau and Heide & von Beckerath in cooperation with the Selbstbaugenossenschaft Berlin eG, is to offer a mix of live and work units that meets the needs of artists and creative professionals, among others. Moreover, the comparatively low land price allowed the cross-subsidisation of co-operative residential and studio

spaces within the project, which can be let at a sustainable rent.

All apartments and studios have different sizes, room heights, and standards of fittings. Some of them have been adapted or linked in the design development stage to adjust the spatial concept to the occupiers' needs.

The underlying principle is that units in the centre of the building are arranged in modules over a depth of 23 metres while units at the ends of the building are designed around the cores and establish differentiated interconnections with their surroundings.

The apartments and studios on levels 0, 1, and 4 and at the ends of the building have barrier-free accessibility. The structure is a combined cross-wall and column construction.

All ground floor spaces are transparent and can be extended into the adjacent public areas.

The owners and representatives of the co-operative have jointly developed the project's social and spatial focus. In view of this, the public and semi-public interfaces with the neighbourhood are given specific attention. The building was designed in such a way that it could be constructed cost-effectively using prefabricated components and largely realised as an Efficiency House 70 (EnEV 2014) with the extensive use of sustainable building materials. The access concepts and floor plans are flexible to accommodate possible conversion and retrofitting as well as adaptation to changing demands. The floor plans for the 66 apartments were designed and detailed in co-operation with the future residents. The 17 studios and three commercial units are conceived as blanks so that the standard of fittings will meet the different needs of the individual occupants. The decision-making process determining the type and position of communal facilities and the development of a binding standard for fittings took place in close collaboration with the building group.

### Note

- In-built flexibility.
- Initiated by and designed with close consultation with future residents.
- Includes binding standards for fittings.



32 Edited version of description provided on architects' websites and in [archdaily.com](http://archdaily.com).



© Photo Andrew Alberts



© Photo Andrew Alberts



© Photo Andrew Alberts



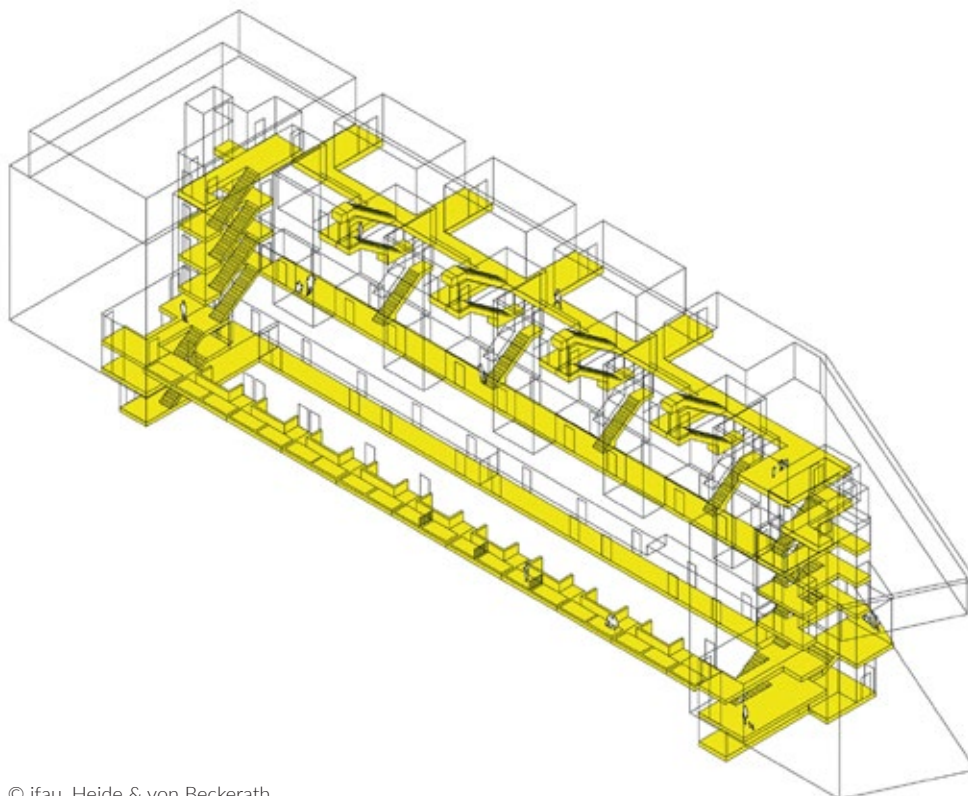
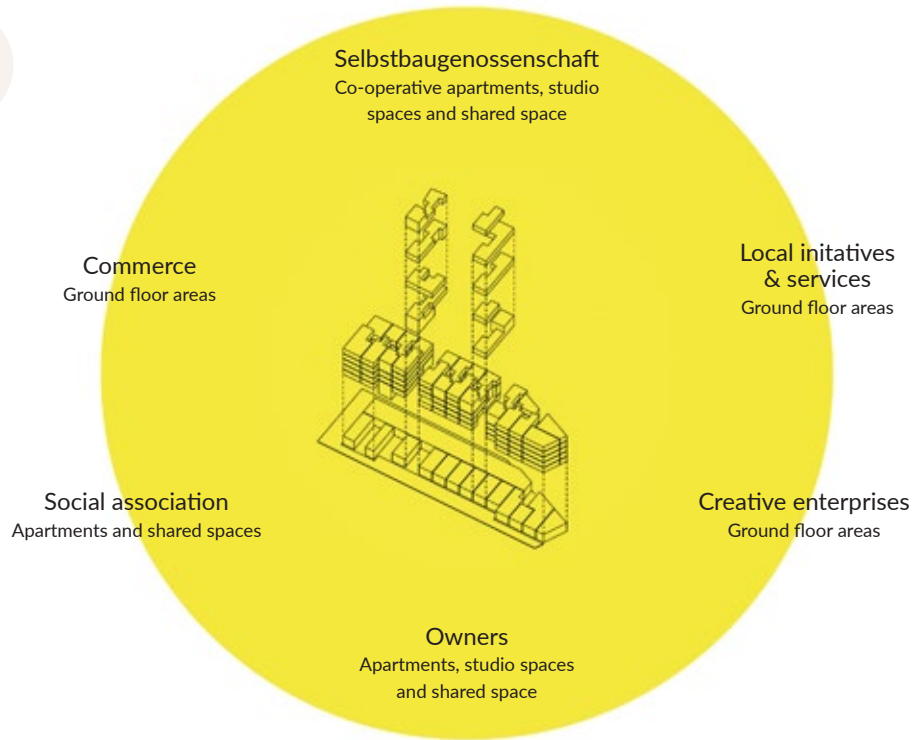



Ground floor

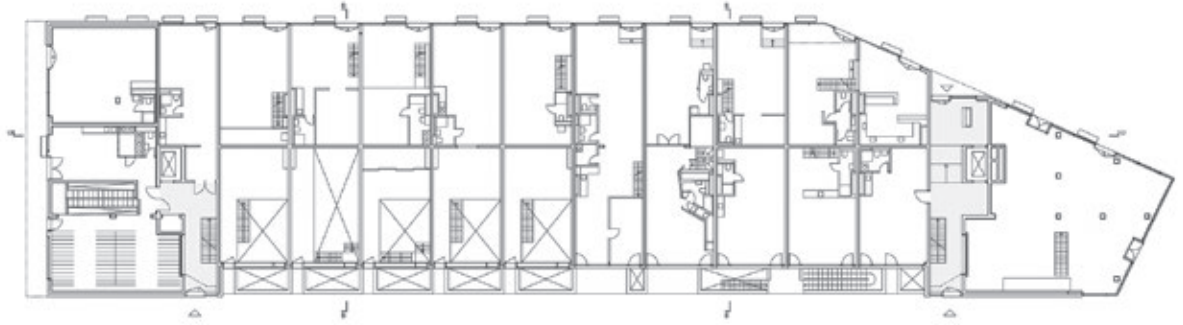

Split level

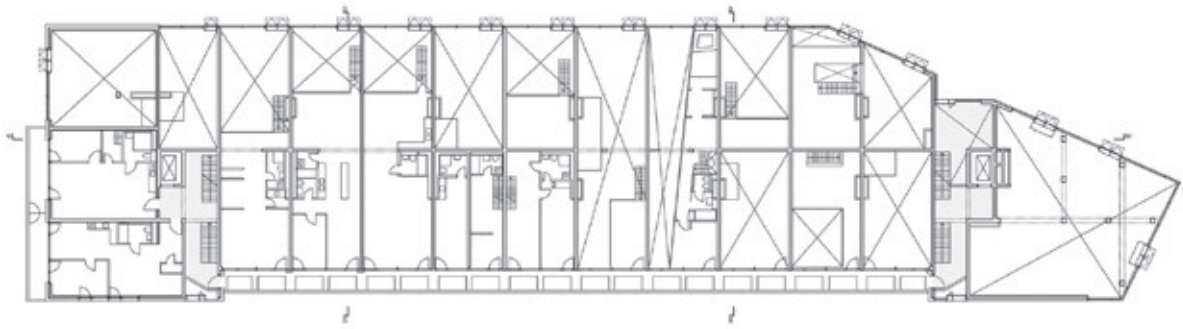

First floor

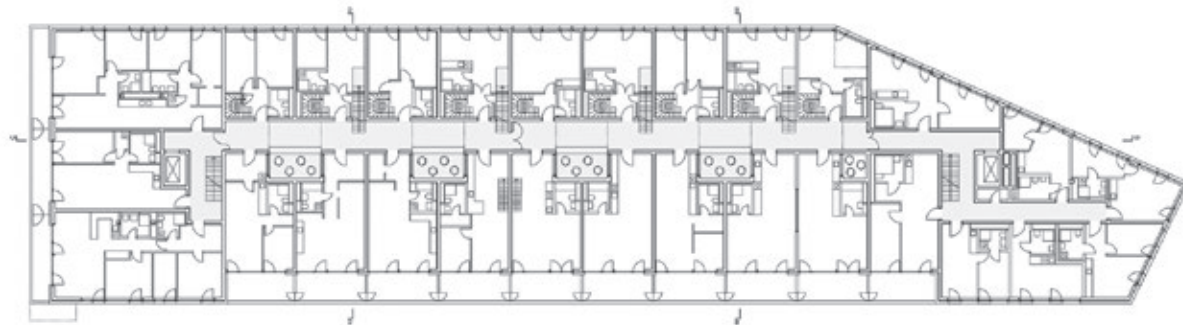

© ifau, Heide & von Beckerath



Second floor

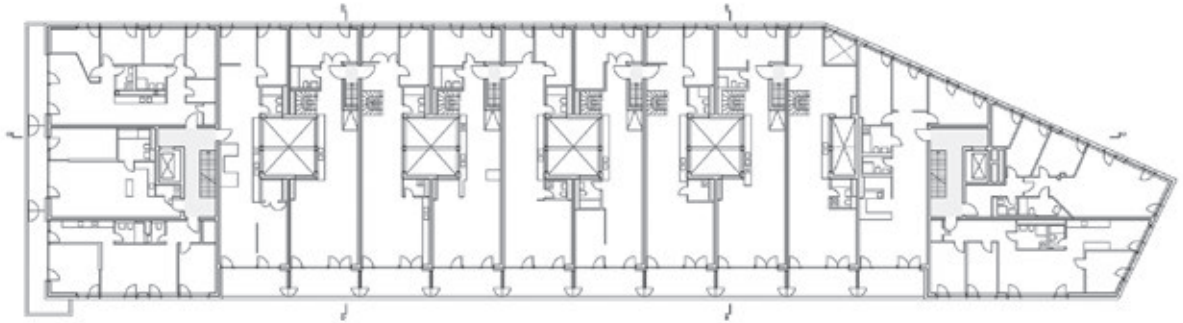

Fourth floor

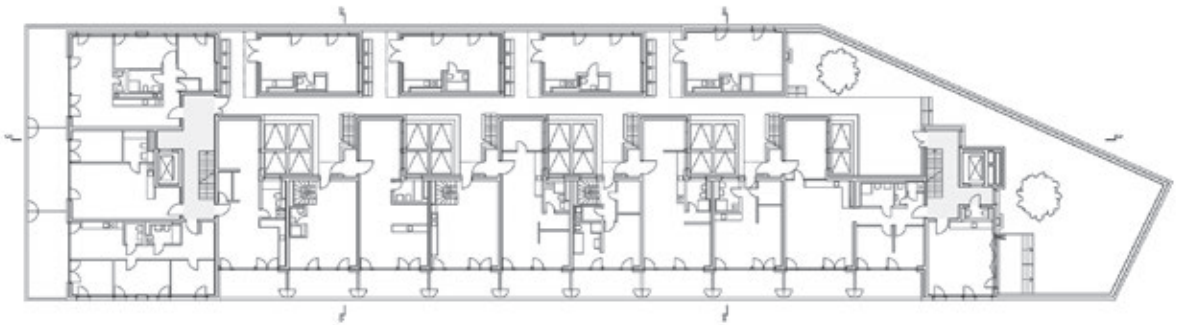

© ifau, Heide & von Beckerath



© ifau, Heide & von Beckerath

# Case study 24: Co-operative housing, River Spreefeld, Berlin



Co-operative development for affordable living and mixed uses



## Location

Berlin, Germany



## Architects

Carpaneto Architekten,  
Fatkoehl Architekten &  
BARarchitekten

[fatkoehl.com](http://fatkoehl.com)

[fatkoehl.com/wohnenmixed-use/spreefeld-berlin/](http://fatkoehl.com/wohnenmixed-use/spreefeld-berlin/)

[www.archdaily.com/587590/coop-housing-project-at-the-river-spreefeld-carpaneto-architekten-fatkoehl-architekten-bararchitekten?ad\\_medium=widget&ad\\_name=recommendation](http://www.archdaily.com/587590/coop-housing-project-at-the-river-spreefeld-carpaneto-architekten-fatkoehl-architekten-bararchitekten?ad_medium=widget&ad_name=recommendation)

## Links

[carpanetoschoeningh.de/carpaneto\\_schoeningh\\_architekten/neubau\\_\\_\\_spreefeld.html](http://carpanetoschoeningh.de/carpaneto_schoeningh_architekten/neubau___spreefeld.html)

## Project details

<b>No. of dwellings:</b>	64
<b>Area:</b>	7,400 m <sup>2</sup>
<b>Mix:</b>	Diverse (with staggered rents)
<b>Construction:</b>	Modular construction
<b>Cost:</b>	€12,470,000
<b>Year:</b>	2013

© Photo Ute Zscharnt



←  
Go to  
contents

### Description<sup>33</sup>

The Co-op Housing is a jointly developed and administered project building that gained experience from many previous self-made projects.

Its mission is to harness its location's unique potential to create a socially just, economically stable, and environmentally responsible urban building block.

- Open to the neighbourhood and city.
- Differentiation between private, communal, and public spaces.
- Options for contemporary forms of living.
- Resource-saving, low-cost building.
- Modular building design, and construction.
- Uniform fittings, sparingly used in the apartments.
- Self-help construction.
- Use-neutral building organization for living and working.
- Self-production of renewable energy.
- Economy of space: few elevators; shared and communal spaces.
- Joint ownership for long-term affordable rents.

The building design consists of predominantly simple support and construction systems that enable a rich variety of options for the organization of various uses. A floor plan atlas as well as a construction kit of standard elements were developed in order to enable a variety of apartment types.



© Photo Ute Zscharnt

In this way no two of the 64 apartment dwellings are alike, although they all follow the same principles.

Particular care was taken to use only environmentally compatible building materials; the use of wood was maximized (wood panel exterior wall, wood wool insulation, solid wood balconies).

In addition to conventional units there are six cluster apartments that provide a communal living structure for groups of 4 to 21 people.

The residential population is quite diverse. It is multigenerational and multicultural, made possible by people both with and without money. Apartments are barrier-free; there is communal use of laundry rooms, fitness rooms, guest rooms, rooftop terraces, and the music and youth room.

The ground floor is largely open to the public, reflecting its attitude to the urban environment. It includes a carpentry workshop, catering kitchen, studios, day care centre, and a co-working space. Available to non-residents are option rooms – unassigned, unfinished spaces for community, social, or cultural projects. Option rooms maintain the project's open character at the juncture of living and urban development.

The ambitious budget helped to focus on the essentials.

In exchange for the required equity capital, users could carry out needed construction work within their own dwellings.

Rents are staggered and start at a level on par with government subsidised housing, without having received this subsidy.

### Note

- Engages with local area through provision of spaces open to the public.
- Variety of residents and housing types including clusters of dwellings.
- Residents carried out construction work within their own dwellings.

33 Edited version of description provided on architects' websites and in [archdaily.com](http://archdaily.com).

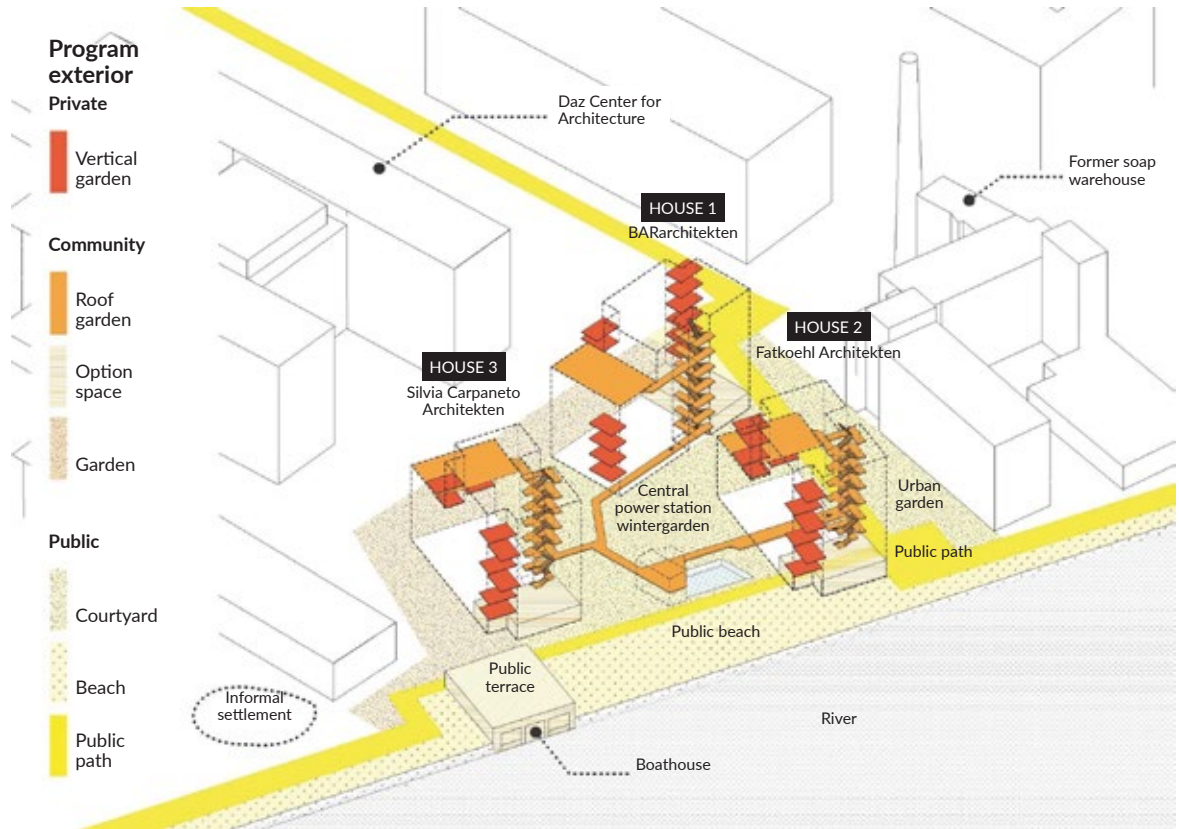

© Carpaneto Architekten, Fatkoehl Architekten, BARarchitekten



© Carpaneto Architekten, Fatkoehl Architekten, BARarchitekten



**Structure**

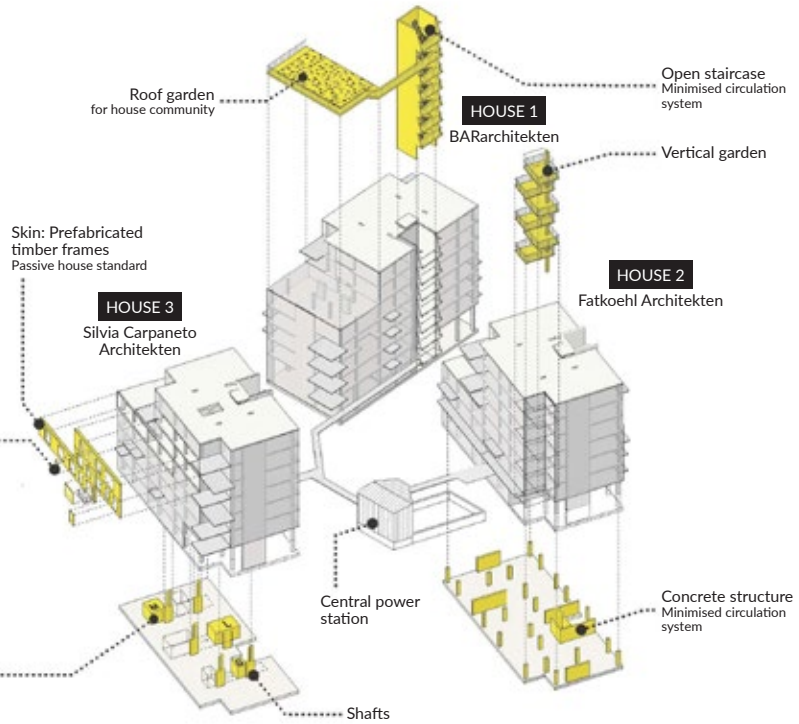
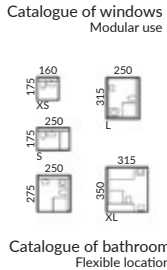
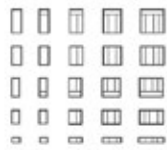
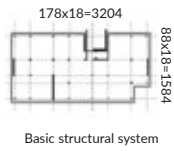

© Carpaneto Architekten, Fatkoehl Architekten, BARarchitekten



© Carpaneto Architekten, Fatkoehl Architekten, BARarchitekten



**Program interior**

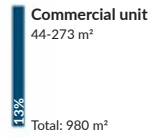
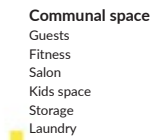
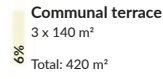
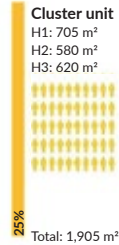
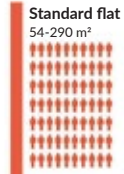

**Total: 7,620 m<sup>2</sup>**

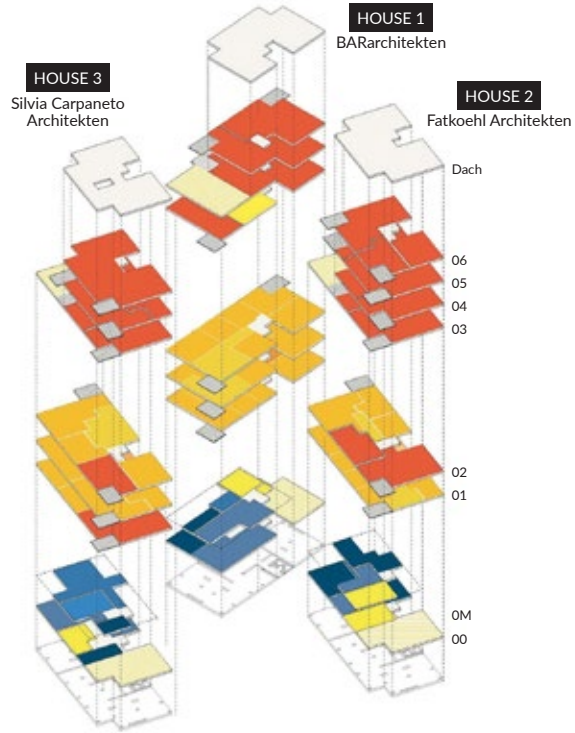

© Carpaneto Architekten, Fatkoehl Architekten, BARarchitekten

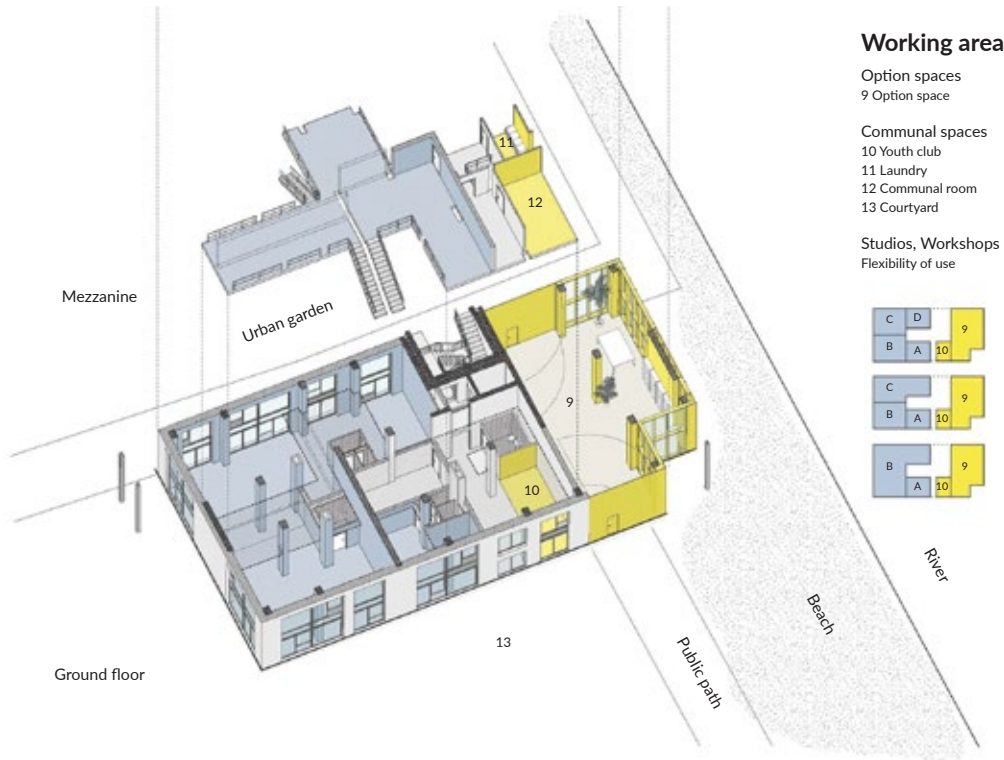

© Carpaneto Architekten, Fatkoehl Architekten, BARarchitekten



# Case study 25: R50 – cohousing, Berlin



## Collective and affordable living



### Location

Berlin, Germany



### Architects

ifau, Jesko Fezer & Heide & von Beckerath

### Links

[www.ifau.berlin/projects/r50](http://www.ifau.berlin/projects/r50)

[www.jeskofezer.de](http://www.jeskofezer.de)

[www.heidevonbeckerath.com](http://www.heidevonbeckerath.com)

[www.archdaily.com/593154/r50-nil-cohousing-ifau-und-jesko-fezer-heide-and-von-beckerath](http://www.archdaily.com/593154/r50-nil-cohousing-ifau-und-jesko-fezer-heide-and-von-beckerath)

### Description<sup>34</sup>

R50 – cohousing is a joint building venture project in Berlin-Kreuzberg. It was initiated by the architects during the course of a concept-based award procedure for building plots and implemented in close cooperation with the clients. The building proposal is founded on a clear urban design position, robust and precisely detailed architectural design, and both a collective and individual process of occupancy.

It comprises three blocks with 19 individual apartments, one studio and various shared spaces. Underneath is a double height, flexible community space which connects the building's main access with the public street space. It is made available for neighbourhood groups and other public uses.

<sup>34</sup> Edited version of description provided on architects' websites: [www.ifau.berlin](http://www.ifau.berlin), [www.jeskofezer.de](http://www.jeskofezer.de), [www.heidevonbeckerath.com](http://www.heidevonbeckerath.com).

### Project details

**No. of dwellings:** 19 apartments, one studio, and shared spaces

**Area:** 2,037 m<sup>2</sup>

**Procurement:** Concept based award procedure

**Construction:** Reinforced concrete and modular timber façade

**Year:** 2013

© Photo Andrew Alberts

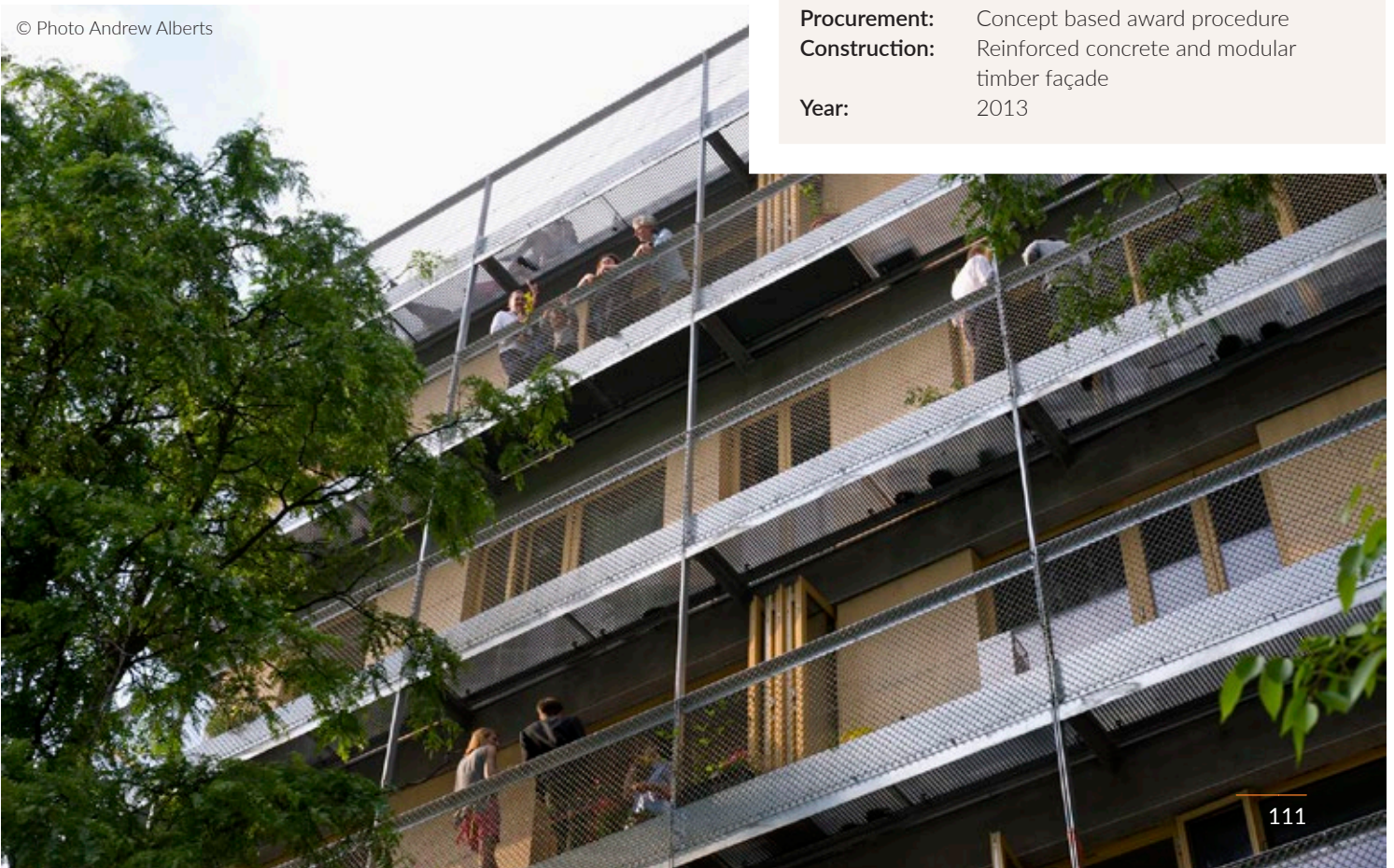

←  
Go to  
contents

A slightly sunken basement level provides access to the building and merges private and public spaces. Each apartment and all additional community spaces were developed by an intensive process of consultations, discussions, and design. Based on the structural framework the sizes of apartments could be determined and individual requirements accommodated in the floor plans. In parallel to this process, a common standard for fixtures and fittings was developed and defined, which has resulted in a collective approach to interior fittings, the use of materials and some surfaces left unfinished, whilst allowing individual layouts of the apartments. This kind of structured yet open design process has not only allowed for extensive participation, self-directed design and self-building, but has also led

to mutual agreement on the type, location, size and design of spaces shared by residents. This includes the generous urban garden, which naturally blends into the landscape of the surrounding 1960s residential neighbourhood, an access ramp leading to a covered area in front of the basement, a laundry, a workshop, and a roof terrace with a summer kitchen and a winter garden. The all-round balconies accompany the bright interior spaces and connect the apartments on each floor.

#### Note

- The building, including shared areas and urban garden, emerged from an intensive consultation with future users.
- Includes a binding standard for fittings.



© Photo Andrew Alberts



←  
Go to  
contents

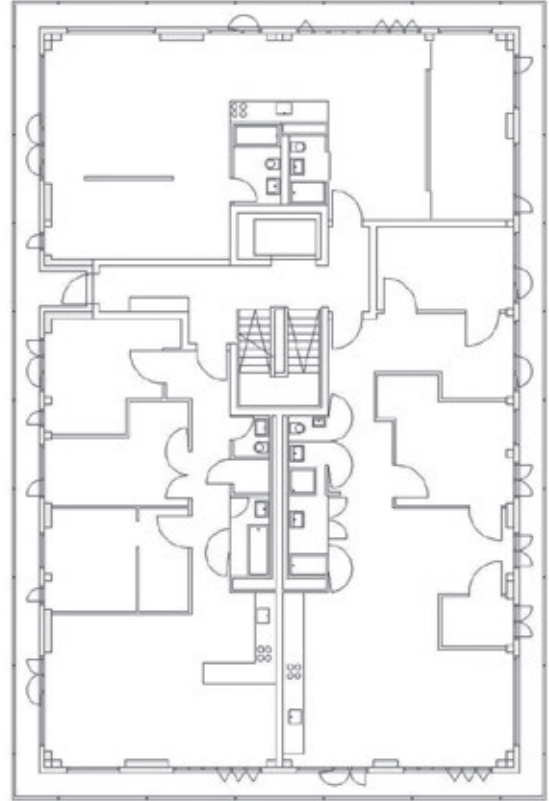
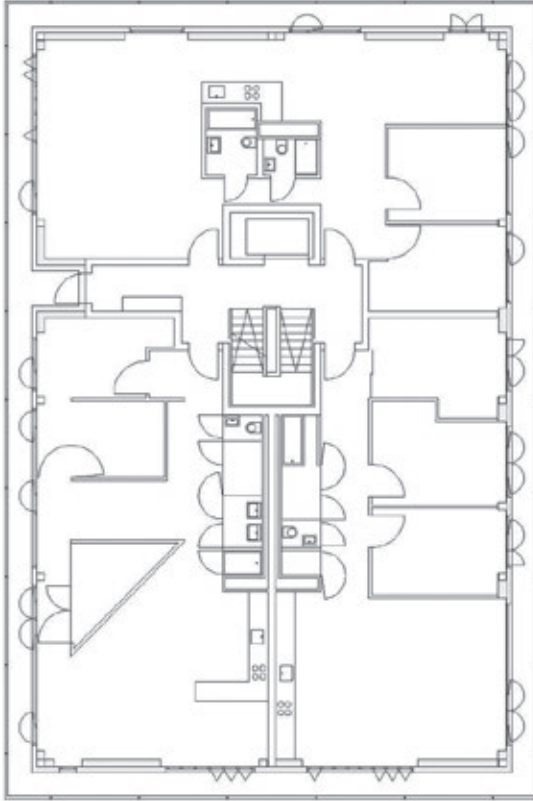

© afau and Jesko Fezer, Heide & von Beckerath

# Case study 26: wagnisART co-operative housing complex, Munich

Co-operative housing (70% subsidised)



Go to contents



## Location

Munich, Germany



## Architects

SHAG Schindler Hable  
Architekten GbR &  
bogevischs buero  
architekten stadtplaner  
GmbH

[www.archdaily.com/889159/cooperative-housing-complex-wagnisart-bogevischs-buero-architekten-stadtplaner-gmbh-plus-shag-schindler-hable?ad\\_source=search&ad\\_medium=search\\_result\\_projects](http://www.archdaily.com/889159/cooperative-housing-complex-wagnisart-bogevischs-buero-architekten-stadtplaner-gmbh-plus-shag-schindler-hable?ad_source=search&ad_medium=search_result_projects)

[www.goethe.de/en/kul/arc/20894807.html](http://www.goethe.de/en/kul/arc/20894807.html)

## Links

[sh-ag.org](http://sh-ag.org)

[www.bogevisch.de/startseite](http://www.bogevisch.de/startseite)

## Project details

**No. of dwellings:** 138

**Area:** 20,275 m<sup>2</sup>

**Mix:** Includes both subsidised and freely financed facilities. 138 dwellings, 400 m<sup>2</sup> of community space and 680 m<sup>2</sup> of commercial space

## Energy

**performance:** Passivhausstandard

**Cost:** €25,000,000

**Year:** 2015

© Photo Julia Knop



←  
Go to  
contents

### Description<sup>35</sup>

The group of buildings consists of five free-standing structures, which were named by the residents after the five continents and which each fit around a central access core. WagnisART is not just a residential building with 9,600 m<sup>2</sup> living surface for the almost 350 residents, but a village within the city with

400 m<sup>2</sup> of community space and 680 m<sup>2</sup> of space for commercial uses. There is a restaurant, an event venue for the neighbourhood, four practice and community rooms, and a wellness area with sauna. The second interior courtyard is conceived as a green oasis, as a retreat space with private gardens for the ground-floor flats.

This village extends into the vertical, since the stairwells with their abundant daylight are used as communication spaces. Wide landings offer space for benches and artworks.

From the fourth storey upwards, one is above the roofs of the city and has a panorama view that includes the distant Alps to the south. If one strolls from bridge to bridge, one passes private loggias, an artist's studio, or the broad "Champagne terrace" that lends itself to sunset community celebrations.

Unique to Munich is the concept of so-called cluster apartments. 84 of a total of 138 flats are organised as shared flats: each cluster apartment has a private sphere with its own cooking niche and bath for each of one to three residents. The community kitchen and joint living space are available to all cluster residents, up to 11 persons, depending on size.

### Note

- Includes 'cluster' flats with shared kitchens for one to three residents and access to a community kitchen and joint living space for up to 11 persons.
- Concept of urban housing as a 'village'.



35 Edited version of description provided on architect's website and description in [archdaily.com](https://www.archdaily.com).





© Bogevischs buero architekten stadtplaner GmbH + SHAG Schindler Hable





### Apartment plans

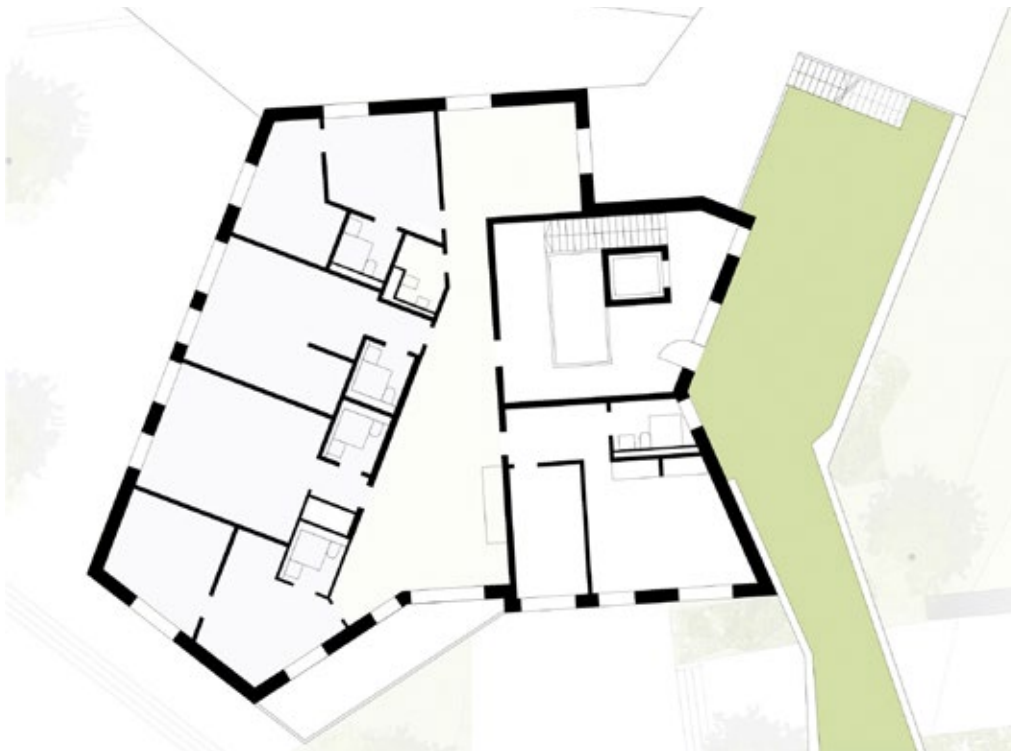

© Bogevischs buero architekten stadtplaner GmbH + SHAG Schindler Hable

# Case study 27: Masterplan for affordable living, Traumhaus Funari, Mannheim



Affordable living in the suburbs



**Location**  
Mannheim, Germany



**Architect**  
MVRDV



**Client**  
MVRDV and Traumhaus  
(home manufacturer)

## Links

[www.mvrdv.nl/projects/239/traumhaus-funari](http://www.mvrdv.nl/projects/239/traumhaus-funari)

[www.archdaily.com/785511/mvrdv-partners-with-traumhaus-to-reinvent-affordable-living-in-the-suburbs](http://www.archdaily.com/785511/mvrdv-partners-with-traumhaus-to-reinvent-affordable-living-in-the-suburbs)

## Project details

**Area:** 27,000 sqm  
**Year:** (2016)/in progress

## Description<sup>36</sup>

MVRDV partnered with Traumhaus, a housing producer which focuses on low-cost high-quality homes based on standardised elements, to design 27,000 m<sup>2</sup> of housing, gardens and public spaces. The scheme is situated in Funari, one of five districts in a major re-development of the Benjamin Franklin barracks in Mannheim. The new village is a catalogue of dwelling and garden typologies, a huge set of variations on Traumhaus' original design, each designed to support a different type of household

<sup>36</sup> [afasiaarchzine.com/tag/mvrdv/page/13](http://afasiaarchzine.com/tag/mvrdv/page/13)





and demographic. The collaboration combines tradition with extravaganza, experience with experimentation, quality with quantity, sharing the ideal of variety and social access with innovation and realisation. Through encouraging a range of different inhabitants to live in the area MVRDV hopes to transform the modern idea of village life with segregated households, into a rich diverse community where individuality and quality of life are paramount.

**Note**

- Interesting project that reconsiders suburban living and that aims to create an affordable, diverse community, using a catalogue of dwellings.

**Section East-West**



© MVRDV

**Housing catalogue**

**Traumhaus 1.0 standard type**



**Traumhaus 1.1**



**Traumhaus 2.0**

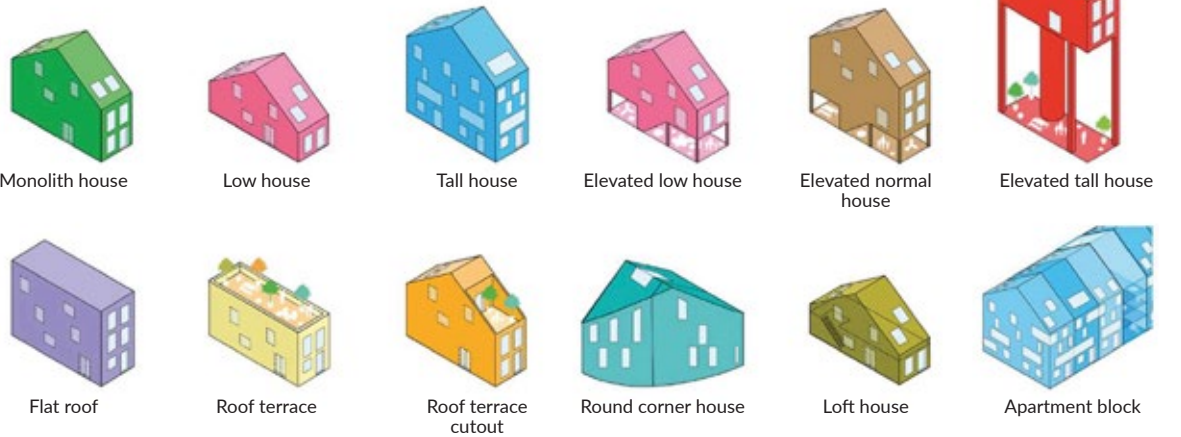

© MVRDV



© MVRDV

### Garden variety example 1

- Elements
- Garden Box
  - Plant Container
  - Expanded Metal Fence
  - Stone Walls
  - Meadow
  - Reed Beds

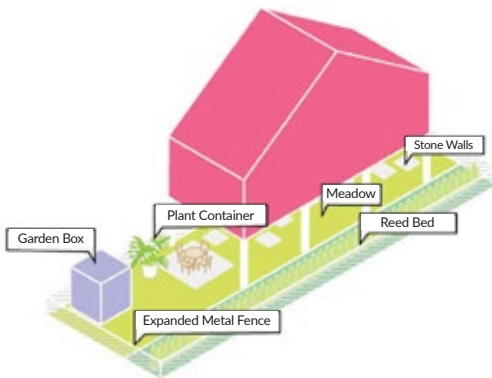

© MVRDV

### Garden variety example 2

- Elements
- Kennel
  - Seating
  - Barbeque
  - Apple Tree
  - Tree Alley
  - Wooden Fence
  - Sunbathing Area

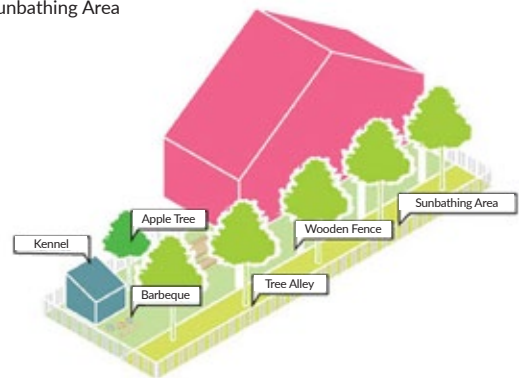

© MVRDV



Traumhaus 2.0 apartment block



High House

+



Glass House

=

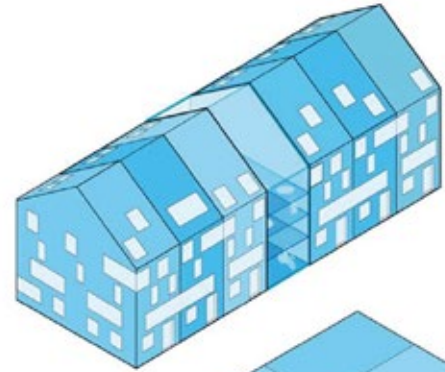

Flat House

+



Glass House

=

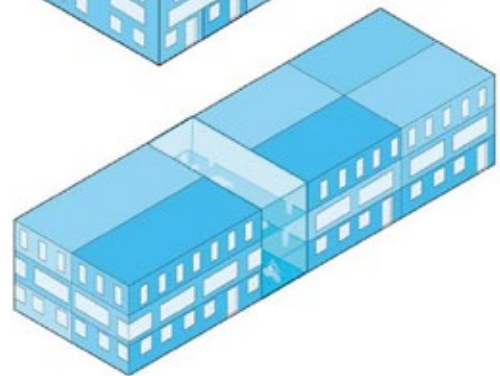

Apartment Block

© MVRDV

# Case study 28: Affordable housing, Frankfurt



## Affordable housing



### Location

Frankfurt, Germany



### Architects

NL Architects & STUDYO

### Links

[www.nlarchitects.nl/slideshow/362](http://www.nlarchitects.nl/slideshow/362)

[www.designboom.com/architecture/nl-architects-terrace-house-studio-frankfurt-germany-04-22-2019](http://www.designboom.com/architecture/nl-architects-terrace-house-studio-frankfurt-germany-04-22-2019)

[www.archdaily.com/915599/nl-architects-plus-studio-design-terraced-affordable-housing-for-frankfurt](http://www.archdaily.com/915599/nl-architects-plus-studio-design-terraced-affordable-housing-for-frankfurt)

### Project details

Mix:	Varied
Procurement:	Competition (2019)
Year:	Ongoing

### Description<sup>37</sup>

Dutch design practice NL Architects and Cologne-based STUDYO have designed a terraced affordable housing complex in Frankfurt. The project is part of the new Hilgenfeld development district in the Nidda valley area of Germany. Called Terrace House, the project was made to encourage shared responsibility while celebrating social gatherings and recreational space. The heart of the project is a communal garden and a terrace of jigsaw balconies.

Terrace House gently steps back each floor to create terraces oriented to the afternoon sun. This stepping gesture on the other side in a way “embraces” the street. Open private balconies emerge on the west and a collective covered gallery access comes into being to the east. The jigsaw figure of the balconies creates a sense of privacy and shelter while at the same time enabling contact between neighbours.

<sup>37</sup> Edited version of description provided on architect's website and description in [archdaily.com](http://archdaily.com).

© NL Architects & STUDYO



←  
Go to  
contents



As the team states, “By introducing small nooks in front of each apartment the gallery becomes more than just infrastructure. A small niche comes into being that can be used for many things, for placing plants, parking a stroller or a bench to have your morning coffee, meet your neighbour, or place your shopping bag to look for your keys. A corner window enables a view along the street.” In addition to the Laubengang as an extended usable area of the apartments, the main entry hall of the Terraces House furnishes another extra area for the residents to meet and greet. Inspired by Ernst May’s famous settlement Römerstadt, Terrace House grants its entire plot area to the residents to take care of as their common ground – tend the garden, plant and harvest fruit trees, to use it as a playground, or as a space to simply gather.

The programme asked for a very large degree of variation of the housing units. Many different sizes are desired to cater for a wide range of future inhabitants for cross-generational and accessible housing. By introducing a building with varying bay widths different apartment types from small to extra-large are organized next to each other forming a gradient that accommodates multiple lifestyles. The living area of the apartments is conceived as an open zone arranged from the entry in the east to the terrace in the west as a continuous space. The kitchens and bathrooms are organized around a service shaft in the centre of each unit allowing the open and the private zone to be placed on either side of the bay to make alternation possible for each floor. The compact individual rooms include a generous living area, even for the smallest apartment types. (Text by Eric Baldwin).



#### Note

- Variety of house types from small to extra-large.
- Communal terraces and gardens designed as social spaces and to encourage shared responsibility.
- Note the design of the deck access balcony.
- Caters for a wide range of inhabitants and provides cross generational and accessible housing.



Floor plan



© NL Architects & STUDYO



# Case study 29: Micro-apartments in Georgengarten, Hannover



Flexible use micro apartments primarily for students



### Location

Lodyweg 1, 30167 Hannover,  
Germany



### Architect

ACMS Architekten



### Client

Studentenwerk Hannover

### Links

[acms-architekten.de/detailseiten-projekte/studentisches-wohnen-lodyweg-hannover](https://acms-architekten.de/detailseiten-projekte/studentisches-wohnen-lodyweg-hannover)

[www.archdaily.com/902875/microapartments-am-georgengarten-acms-architekten?ad\\_source=search&ad\\_medium=search\\_result\\_projects](https://www.archdaily.com/902875/microapartments-am-georgengarten-acms-architekten?ad_source=search&ad_medium=search_result_projects)

### Project details

No. of dwellings: 80

Area: 6,500 m<sup>2</sup>

Energy performance: Close to passive house standard achieved by optimising the surface area/volume ratio

Year: 2016



© Photo Sigurd Steinprinz

←  
Go to  
contents

### Description<sup>38</sup>

The new buildings were funded by the Ministry of Social Affairs, Health and Equality for Lower Saxony to facilitate the provision of affordable homes in conurbations for low-income households and to improve the quality of the rented housing stock. The student apartments on Ladyweg can also be offered, depending on need, to other demographic groups such as the elderly, single people of any age or apartment-sharing groups. Changing the room structure, for example by combining several spatial units together, can be easily done thanks to the lightweight construction of all the party walls.

No new student halls of residence had been built in Hanover for 20 years. The project, which consists of 80 new apartments, provides attractive and inexpensive living space near Leibniz University Hanover.

Minimising the circulation space within the buildings and placing the access stairways on the outside achieves a very high space efficiency quotient. Two blocks are served by one shared, open stairwell.

Lifts can be installed as an option. The building modules were arranged flexibly in rows or groups and sensitively integrated with the existing trees. Because the site is on the floodplain of the River Leine, no living space has been designed for the ground floor of the new buildings. The ground floor plinth with its robust masonry facing instead contains the student services organisation's working rooms and offices. Should the need arise, these can be used for other purposes – such as offices, administration, or business purposes. The apartments on the upper floors can be combined variously to create larger residential units thanks to the party walls between them being free of building services installations. The concept of adding such housing modules of various sizes to a site is transferable to other urban spaces where an increased density of development is to be achieved while integrating with the existing urban context.

### Note

- **Attractive micro apartments for students designed so they can be combined in the future to create larger residences.**

---

38 Edited version of architect's description in [archdaily.com](https://www.archdaily.com).



←  
Go to  
contents

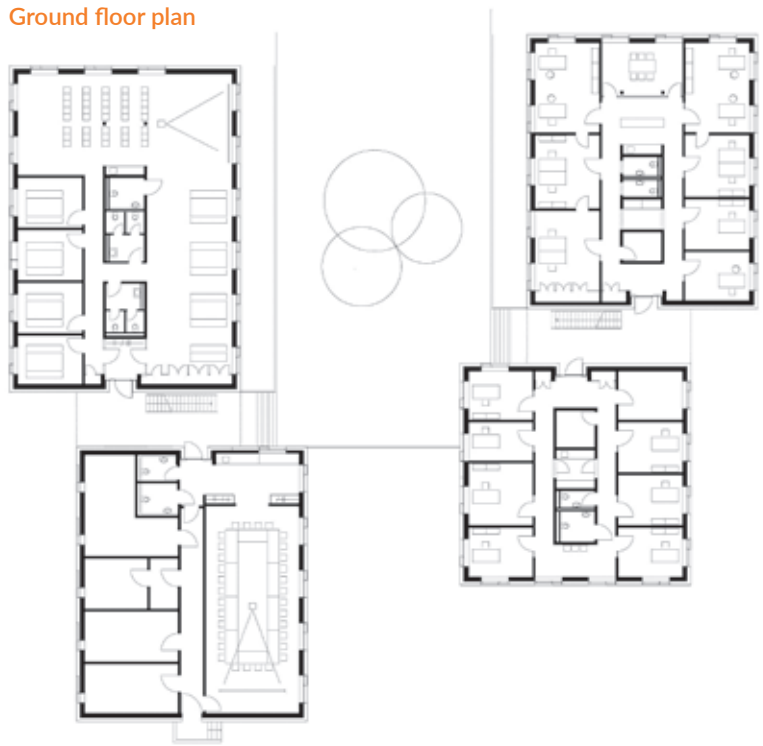

© ACMS Architekten

# 6 / The Netherlands



Social, co-operative, and affordable housing in the Netherlands	132
Case Study 30: Holland Park West, Diemen	134
Case study 31: Multi-generational housing including live work-spaces, Katwijk	136
Case study 32: Groene Mient, co-operative housing, the Hague	138
Case study 33: Timmerhuis, mixed use architecture, Rotterdam	142
Case study 34: Block A, Noordstrook, social housing, Amsterdam	145
Case study 35: Startblok Riekerhaven, experimental housing, Amsterdam	148
Case study 36: De Flat Kleiburg, Amsterdam	150
Case Study 37: Mix of houses and apartments, Arnhem	154

# Social, co-operative, and affordable housing in the Netherlands



**Population**  
17,134,872  
(2020)



**Dwellings**  
7,200,000



**Tenure<sup>39</sup>**  
Social rent: 33%  
Private rent: 7%  
Owner occupier: 60%



**Housing providers**  
Housing corporations

The Netherlands has 3.2 million rental properties, of which 2.7 million are in the social sector. This attainment has been under pressure and the percentage of (social) rental housing has declined in recent years. Across the board, the importance of social housing is again being recognised, and relations between municipalities, associations, and tenants, frayed in recent years, are being repaired.

Social housing, known as “sociale huurwoningen,” is offered to citizens at a subsidised rate. Those living in subsidised homes pay no more than €710.68 per month, with the government contributing the remainder. Rent controls mean that prices cannot rise by more than 4.3% per year.

Housing is administered through a points system, which determines the value of the property the applicant will live in, and hence their rent. Oversight of the system

is carried out by the Centraal Fonds Volkshuisvesting (central housing fund). Housing associations, known as “toegelaten instellingen,” manage social housing in the Netherlands, as well as the surrounding neighbourhood. The housing associations also must appoint caretakers for the area. They are basically responsible for making sure that the area is kept in good condition, preventing crime, and maintaining public facilities, from playgrounds to car parks. They manage over 2.4 million units nationwide.

Housing policy in the Netherlands is partly decentralised, with local governments responsible for ensuring supply, and the national government for affordability.

The Netherlands consists of twelve municipalities each with local responsibility for areas such as the environment, spatial planning, and traffic. After

There are **3.2** million rental properties in the Netherlands

**2.7** million rental properties (almost one in three of all dwellings) are in the social sector

**4.3%** is the maximum annual increase in rental costs due to rent controls

## References

Archdaily: [www.archdaily.com/932075/comparing-social-housing-in-countries-around-the-world?ad\\_source=search&ad\\_medium=search\\_result\\_all](http://www.archdaily.com/932075/comparing-social-housing-in-countries-around-the-world?ad_source=search&ad_medium=search_result_all) (accessed October 2020).

Global Housing Debt: [www.globalhousingdebt.org/a-short-overview-of-the-public-housing-in-the-netherlands](http://www.globalhousingdebt.org/a-short-overview-of-the-public-housing-in-the-netherlands) (accessed October 2020).

e-architect: [www.e-architect.co.uk/holland/dutch-housing](http://www.e-architect.co.uk/holland/dutch-housing) (accessed October 2020).

International Journal of Housing Policy: [www.tandfonline.com/doi/full/10.1080/19491247.2019.1663056](http://www.tandfonline.com/doi/full/10.1080/19491247.2019.1663056) (accessed October 2020).

ASSEMBLE Papers: [assemblepapers.com.au/2018/12/13/amsterdam-social-housing-a-primer](http://assemblepapers.com.au/2018/12/13/amsterdam-social-housing-a-primer) (accessed October 2020).

European Housing Standards: [www.researchgate.net/publication/286459958\\_European\\_housing\\_standards](http://www.researchgate.net/publication/286459958_European_housing_standards) (accessed October 2020).

<sup>39</sup> Karausevc, Paul and Batchelor, Abigail: Social Housing Definitions and Design Examples, RIBA Publishing (2017).



acquiring the land for a housing development, the municipalities take responsibility for site preparation, infrastructure and street layout. Municipalities can use their land-use plans to exert influence on the composition of the housing stock including the rental stock.

#### **Points of special interest**

- With a few recent exceptions, the human scale of the housing provided, and the emphasis on person, and community centred design.
- The ability of non-market housing to address the requirements of different groups of residents.
- The strong urban design context that informs most housing developments.
- The way in which housing design supports the formation of communities – in, for example, the provision of shared open spaces and the use of gallery type access to apartments
- The wide variety of housing typologies indicates a pragmatic approach to addressing housing need.

# Case study 30: Holland Park West, new mixed residential development, Diemen



## Mixed residential



### Location

Diemen, the Netherlands



### Architect

Mecanoo

### Link

[www.mecanoo.nl/Projects/project/259/Holland-Park-West?t=13](http://www.mecanoo.nl/Projects/project/259/Holland-Park-West?t=13)

### Project details

<b>No. of dwellings:</b>	706
<b>Procurement:</b>	Competition
<b>Car spaces:</b>	Car free
<b>Year:</b>	2020 (design), ongoing

### Description<sup>40</sup>

Holland Park West will be a new residential area within the Holland Park neighbourhood. The plan, called Xplore, consists of 706 homes. Of these, 212 social rental homes and 170 medium-priced rental homes will be realised. The plan also plans for 1,500 m<sup>2</sup> of facilities and a community school. This school will provide space for around 700 primary school pupils, a day-care centre and a playgroup.

The Xplore plan is designed in such a way that there is as much interaction as possible between residents of all generations and ages – whether at school, within the green spaces, or between buildings. This scheme also ensures the development of a completely car-free vision, which includes four green residential courtyards which provide intimacy and security.

40 Edited version of description provided on architect's website.

© Image Plo.mp





←  
Go to  
contents

The facilities and school are positioned in strategic locations to bring liveliness to the green heart of the neighbourhood. The entire development has also been designed with plenty of attention to biodiversity and circularity. All felled wood is re-used and biodiversity of the area enhanced. The landscape is green and climate adaptive while the buildings are designed to be energy neutral.

The procedure to define the zoning plan will start before the end of 2019, so that the school and first phase housing can be occupied as early as 2022. The

built delivery of the final homes is planned for 2025. The Xplore plan is part of the larger Holland Park area development, the former Berwijckpark-Noord business park, where a total of more than 5,000 homes are being realized.

#### Note

- **New car free. mixed, bio-diverse, neighbourhood, that is being designed to encourage interaction between all residents. Housing mix unknown.**
- **Note the attention given to creating a bio-diverse environment.**



# Case study 31: Multi-generational housing including live work-spaces, Katwijk



## Social housing Sandtlaan



### Location

Katwijk, the Netherlands



### Architect

HVE Architecten

### Links

[hve-architecten.nl](http://hve-architecten.nl)

[www.archdaily.com/137091/social-housing-sandtlaan-hve-architecten?ad\\_source=search&ad\\_medium=search\\_result\\_projects](http://www.archdaily.com/137091/social-housing-sandtlaan-hve-architecten?ad_source=search&ad_medium=search_result_projects)

### Description<sup>41</sup>

The project comprises apartments for returning (senior) residents of the demolished buildings on the site, a sheltered living project for young people,

40 Edited version of description provided on architect's website.

and several single-family dwellings with and without incorporated working space for starters on the housing market.

The single-family dwellings are grouped in two clusters. Each cluster consists of four dwellings of two floors and four dwellings of three floors with room for office space. These clusters are situated on the footprint of the former apartment buildings in order to maintain the existing views from the adjacent houses.

The apartment block functions as a point of entrance to the neighbourhood. The ground and fifth floor have apartments for senior citizens. The living units for the sheltered living project are grouped together on the second and third floor, with a collective living

### Project details

<b>No. of dwellings:</b>	Unknown
<b>Area:</b>	4,500 sqm
<b>Mix:</b>	Older people young people and single family dwellings
<b>Year:</b>	2011

© Photo HVE Architecten

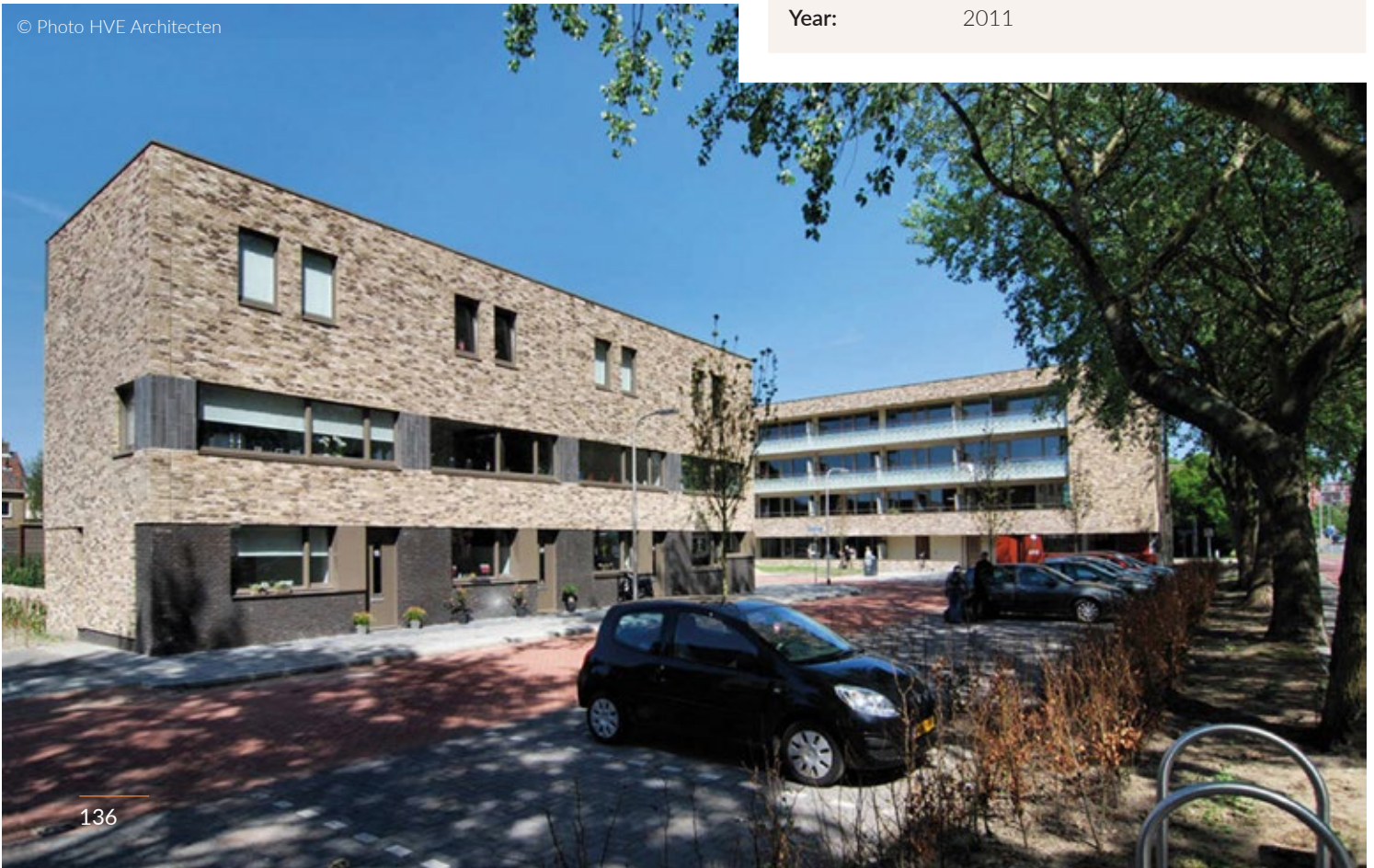



# Case study 32: Groene Mient, co-operative housing, the Hague



## Affordable co-operative housing



### Location

Paesi Bassi, the Hague



### Architects

FilliéVerhoeven Architecten &  
Architektenkombinatie Bos Hofman



### Client

CPO Groene Mient

### Links

[fillieverhoeven.nl](http://fillieverhoeven.nl)

[architektenkombinatie.nl/portfolio-view/groene-mient-den-haag](http://architektenkombinatie.nl/portfolio-view/groene-mient-den-haag)

[www.groenemient.nl](http://www.groenemient.nl)

### Project details

No. of dwellings: 33

Area: 85-165 m<sup>2</sup>

Energy performance: Low energy – south orientation with solar collectors

Cost: €155,000–€ 265,000  
(Construction cost)

Year: 2017

© Photo François Verhoeven

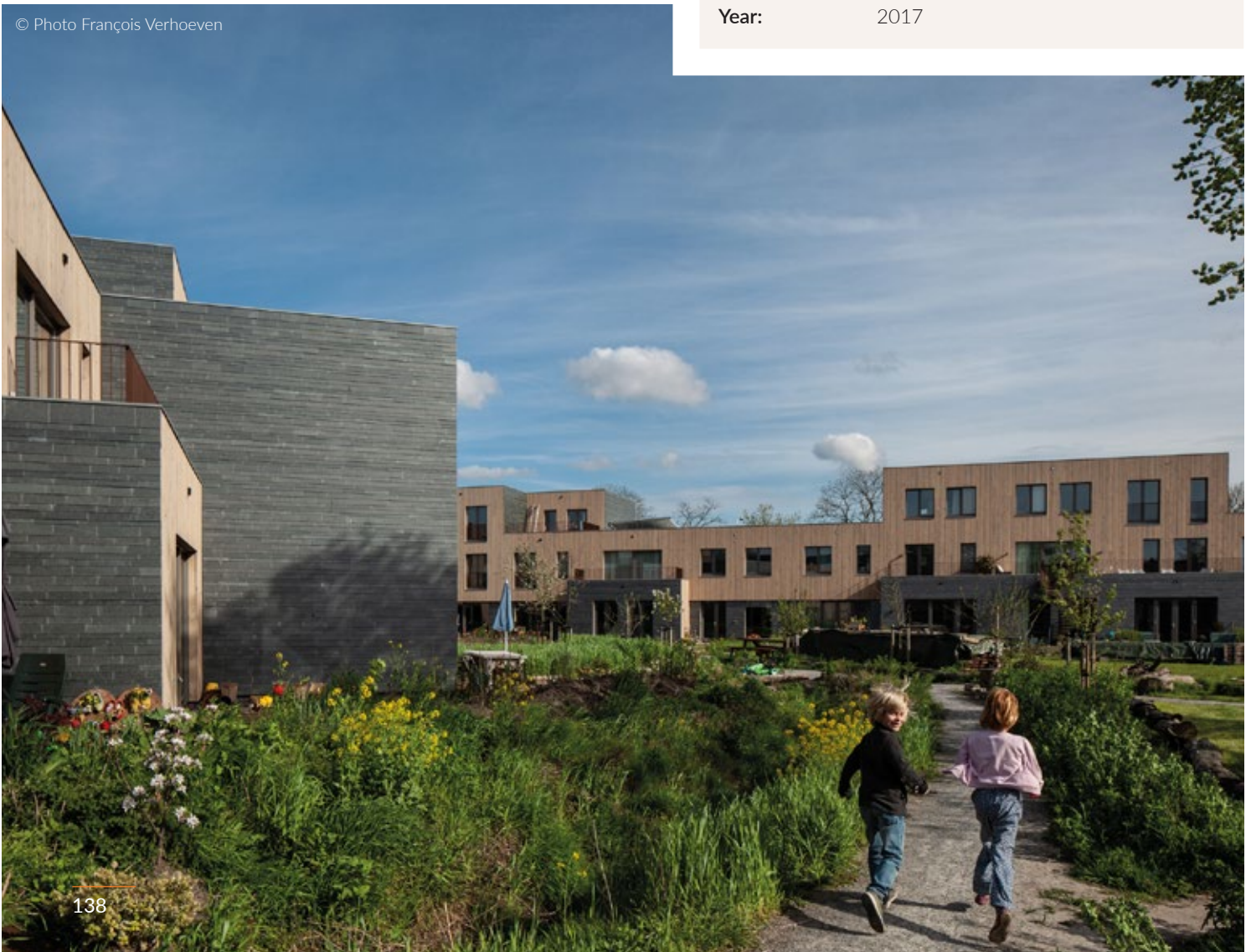

←  
Go to  
contents

### Description<sup>42</sup>

This project was designed by FilliëVerhoeven Architecten in co-operation with Architectenkombinatie Bos Hofman for the housing co-op of 33 families, Groene Mient. It is a low energy housing project built in wood and slate.

Groene Mient provided the architects with an opportunity to create an enormous collective garden and to focus all new houses equally on this collective garden in such a way that it would not result in a subdivision into different smaller backyards.

Another important design wish was that the new houses should be south orientated as much as possible given the strive for minimal energy consumption and the use of solar panels and solar collectors.

The three building blocks respond to their urban location.

Residents had individual preferences for both natural and orthogonal shaped dwellings which is expressed in the plan.

The residents were all separate developing commissioners organized in a CPO (Collective Private Commissioners Organization).

This way the architecture is a tool for this community to shape a rough piece of slate Vega Verde (which in Spanish means 'Groene Mient', green pasture) and a small piece of the city into the most appropriate form for the residents.

### Note

- **Urban block with a variety of house types to allow for individual preferences built around a large shared open space.**

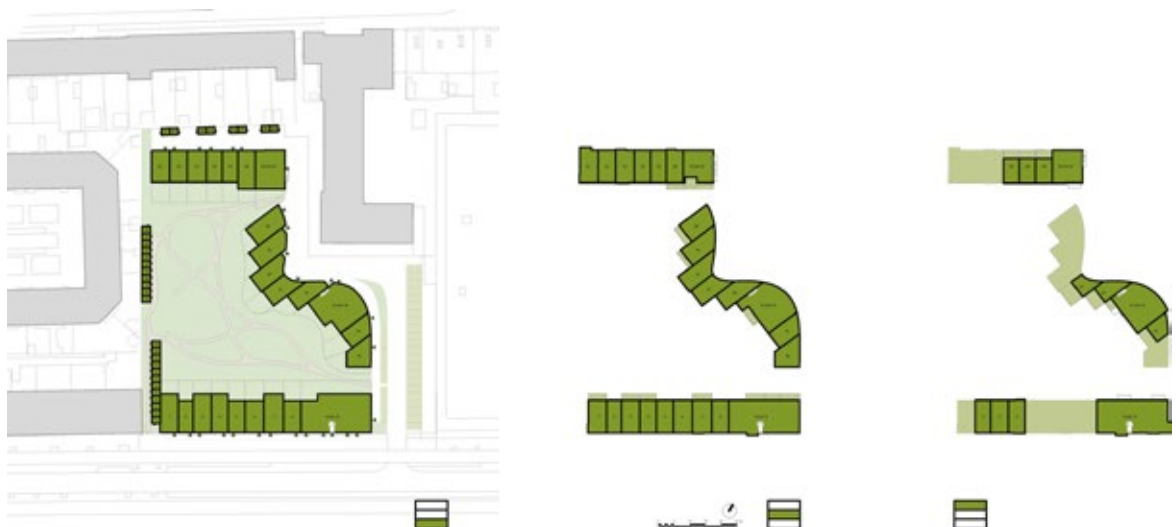

© FilliëVerhoeven Architecten & Architectenkombinatie Bos Hofman

42 Edited version of description provided on architect's website and description in [archdaily.com](http://archdaily.com)





# Case study 33: Timmerhuis, mixed use architecture, Rotterdam



Mixed use architecture, apartments, office buildings



## Location

Rotterdam, the Netherlands



## Architect

OMA

## Links

[oma.eu/projects/timmerhuis](http://oma.eu/projects/timmerhuis)

[www.archdaily.com/778654/timmerhuis-oma](http://www.archdaily.com/778654/timmerhuis-oma)

[www.dezeen.com/2015/12/10/oma-pixelated-timmerhuis-complex-rotterdam-netherlands](http://www.dezeen.com/2015/12/10/oma-pixelated-timmerhuis-complex-rotterdam-netherlands)

## Project details

**Area:** 45 000 m<sup>2</sup>, 12 000 m<sup>2</sup> residential

**Mix:** Office: 25,400 sqm

Residential: 12,000 sqm

Parking: 3,900 sqm

Retail: 2,070 sqm

Museum/gallery: 1,630 sqm

## Construction:

Cuboidal modules, each measuring 7.2 metres wide, 7.2 metres deep and 3.6 metres high

## Energy performance:

Flexibility, use of atriums to create a climate system and triple glazed façade

## Car spaces:

3,900 sqm

## Year:

2015



© Photo Sebastian van Damme, OMA



←  
Go to  
contents

### Description<sup>43</sup>

The architects, OMA, have merged a municipal office block from the 1950s with a pixelated steel and glass structure to create a new mixed-use building in Rotterdam's city centre. Timmerhuis is an unusual residential project that integrates municipal offices with residences and retail. OMA restored an existing government building and added two mountain-like towers, with generous receding terraces with outdoor space for residences.

The building houses a diverse demographic, including young families and empty-nesters.

The Timmerhuis's innovative structural system generates maximum efficiency and versatility both in construction and in the program: units can adapt to either office space or residential use as desired.

Green terraces on higher levels provide apartments with a garden in the heart of urban Rotterdam. On the street level, the structure allows for generous open space, with modules overhanging rather than encroaching into an interstitial area, encouraging an active and open engagement between the Timmerhuis and the city.

The design brief stipulated that the Timmerhuis must be the most sustainable building in the Netherlands.

OMA tackled this imperative through the building's core concept of flexibility, and, also through the two large atriums, which act like lungs. They are connected to a climate system that stores warmth in summer and cold in winter and releases this energy as warm or cold air as required. The building's triple glazed curtain wall façade uses hi-tech translucent insulation that allows for unprecedented energy efficiency.

Rather than being yet another statement in Rotterdam's crowded history of revisionist planning and cacophony of architectural styles, the ambiguous mass of the Timmerhuis tries to mediate between the existing buildings surrounding it. The axis between the existing town hall and the post office coincides with the axis of symmetry of the Timmerhuis, and the street between these two buildings continues into a passageway to the Haagseveer. The Timmerhuis integrates with the neighbouring Stadttimmerhuis by maintaining the same floor heights, while the plinth height of 20m conforms to the character of the surrounding Laurenskwartier.

### Note

- A mixed-use development (offices, residences, and retail) with a structural system that provides flexibility, which is recognised as a key component in sustainability.

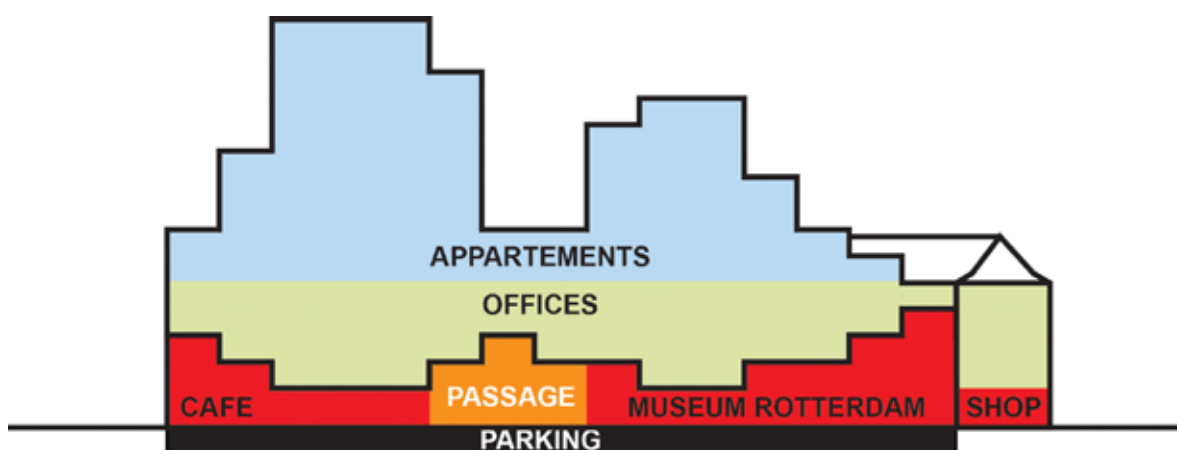

© OMA

40 Edited version of description provided on architect's website.

←  
Go to  
contents

Sixth floor plan



© OMA

# Case study 34: Block A, Noordstrook, social housing, Amsterdam



Go to  
contents

Mixed use architecture, apartments, office buildings



## Location

Slotervaart, Amsterdam,  
the Netherlands



## Architect

Dick van Gameren  
Architecten

## Link

[www.archdaily.com/167540/block-a-noordstrook-dick-van-gameren-architecten?ad\\_source=search&ad\\_medium=search\\_result\\_projects](http://www.archdaily.com/167540/block-a-noordstrook-dick-van-gameren-architecten?ad_source=search&ad_medium=search_result_projects)

## Description<sup>44</sup>

Block A is the first of three new blocks of buildings north of Delflandplein in the Amsterdam district of Slotervaart.

<sup>44</sup> Edited version of architect's description in [archdaily.com](http://archdaily.com).

Maximum density was strived for in the first new block of buildings to set a large-scale renovation of the Delflandplein neighbourhood into motion: 170 social council dwellings, a day activity centre and business spaces, that replace the original building.

The largest possible variety of housing types and sizes were built in the block, ranging from small studios with common living rooms for people in need of care to relatively spacious six-room maisonettes and large five-room apartments.

## Project details

**No. of dwellings:** 174

**Mix:** 170 dwellings, parking for 170 vehicles and 2,800 m<sup>2</sup> of commercial space and a community centre with dwellings for the elderly, starters and families

**Construction:** Cast concrete floors and walls and prefabricated concrete panels of patterned brickwork

**Car spaces:** 174

**Year:** 2009

© Photo Marcel van der Burg

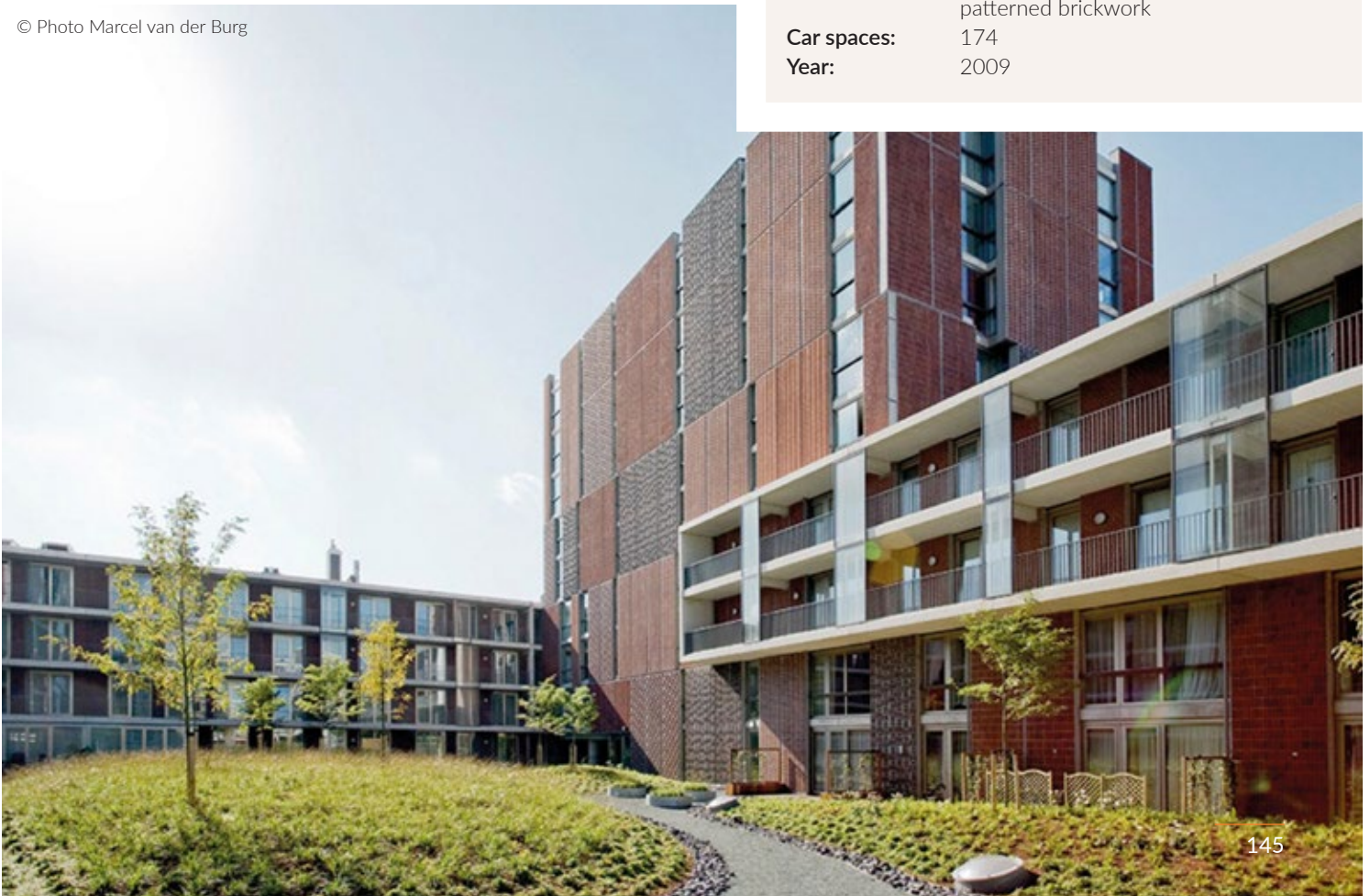

←  
Go to  
contents

The trend towards reducing the programme for stacked dwellings to average three-room apartments of 90 m<sup>2</sup> was thus avoided. As a result, it was possible to build multiple types of residences in this block, and the original ideals of the western suburbs – a balanced differentiation of dwellings for the elderly, starters and families – have been restored here in an updated form.

An inner garden is created on a car park in the heart of the building. Earthen hills make it possible to place large trees in the grass.

The considerable noise pollution from the nearby A10 Amsterdam ring road informed the façade design. The two higher parts of the U-shaped block have a very closed façade facing the ring road. The opposite west side, on the other hand, was made as open as possible with large frontages and outer areas. The large prefab concrete façade panels, containing brickwork, allude to the original brick assembly technique used in Slotervaart, but at the same time attempt to break with the monotonous, repetitive appearance of traditional prefab façades.

By arranging multiple types of residences around a central courtyard, Noordstrook reinterprets the original ideals of the western suburbs – a balanced differentiation of dwellings for the elderly, starters, and families.

#### Note

- **Variety of dwelling types and deliberate decision to avoid providing one apartment type and to replicate the mix found in sub-urban housing.**
- **The façade is designed to respond to the location.**



© Dick van Gameren Architecten

#### First floor plan



eerste verdieping - 1st floor



© Dick van Gameren Architecten

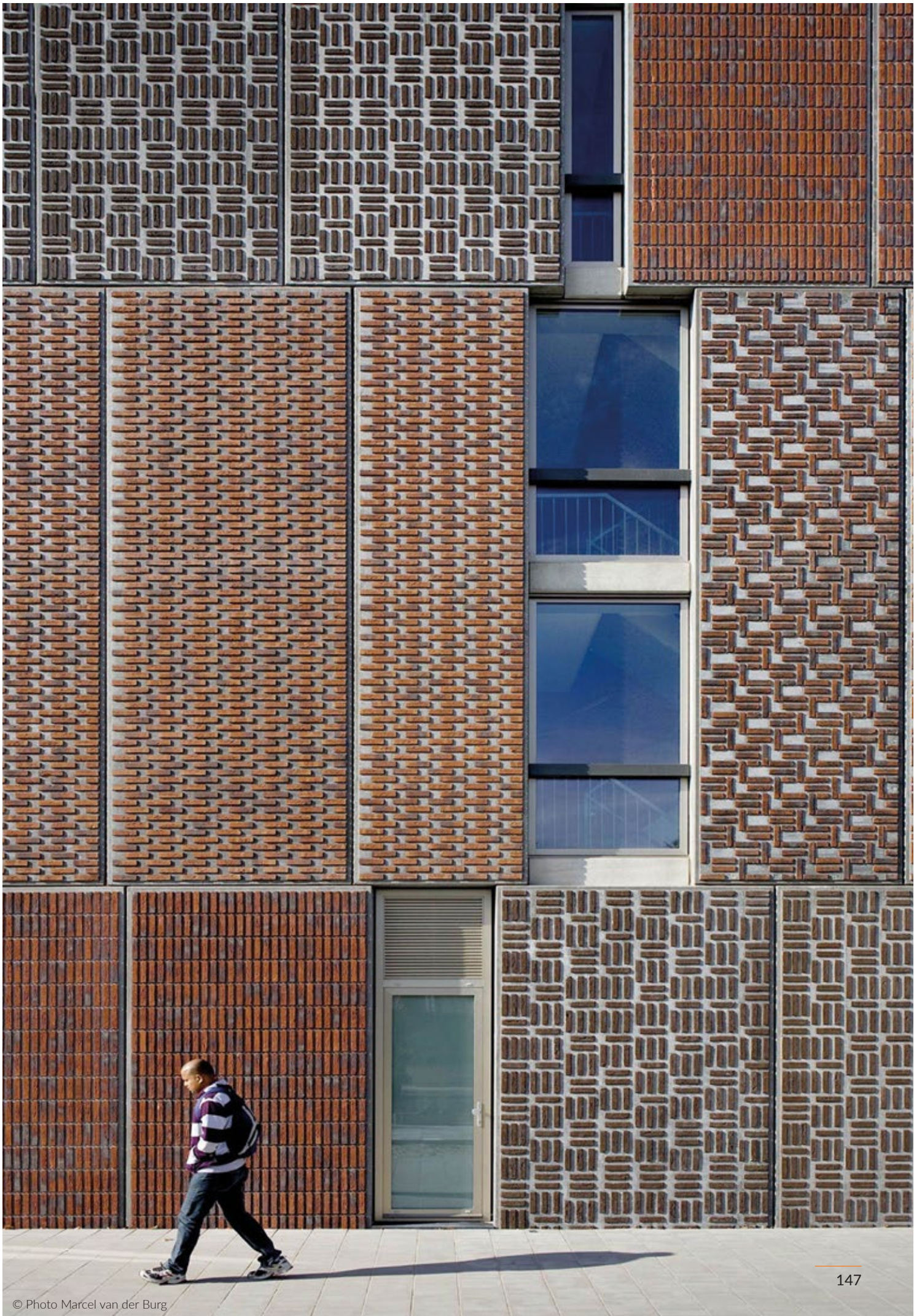

# Case study 35: Startblok Riekerhaven, experimental housing, Amsterdam

←  
Go to  
contents

Temporary experimental housing solution  
(self-managed and self-organised low-cost housing)



## Location

Amsterdam, the Netherlands



## Architect

HVDN Architecten



## Client

De Key

## Links

[startblokkriekerveen.nl/en/living-startblok/housing-units](http://startblokkriekerveen.nl/en/living-startblok/housing-units)

[www.hvdn.nl](http://www.hvdn.nl)

## Project details

**No. of dwellings:** 565 (463 studios and 102 rooms in multi-person apartments)  
**Mix:** 18-27 year-old Dutch nationals and refugees (283 refugees and 282 Dutch)  
**Year:** 2016

## Description<sup>45</sup>

In 2015, the housing association, De Key, had a large number of modular housing units located within disused shipping containers from a previous development project. The Municipality of Amsterdam granted them access to use a former sports ground to house these containers/units and establish a temporary residential community, Startblok Riekerhaven.

Startblok Riekerhaven is home to 565 young people, all between the ages of 18-27, in Amsterdam. Half the residents are Dutch and half are refugees who have recently received their residence permit (status-holders). There are 463 studios and 102 private rooms in multi-person apartments. The studios are approximately 23 square metres and have their own small kitchen and bathroom. All living spaces are provided unfurnished. Each floor has a communal living space for social activities and there are two large outside areas.

Startblok opened in July 2016 with a focus on social integration combined with affordable housing. The project will cease in its current form in 2026 – the shipping containers are second-hand and are not expected to last beyond this time-period. Additionally, the municipality's lease of the land will expire, and it has already been purchased privately.

## Note

- Note focus on integration in this short-term approach to addressing housing need at an affordable level.



© Photo Startblok Riekerhaven

<sup>45</sup> Text based on description provided on Startblok website.



Aan deze tekening kunnen geen rechten worden ontleend. Afmetingen bij benadering  
 This floor plan is just an indication. No rights can be derived from this blueprint.

- |   |                           |   |                        |
|---|---------------------------|---|------------------------|
|  | Kamer                     | - | Room                   |
|  | Gedeelde hal/berging      | - | Shared hallway/storage |
|  | Gedeelde keuken/woonkamer | - | Shared kitchen/living  |
|  | Gedeelde badkamer         | - | Shared bathroom        |

© Startblok Riekerhaven

# Case study 36: De Flat Kleiburg, Amsterdam



Residential revamp – do it yourself housing



## Location

Amsterdam, the Netherlands



## Architects

NL Architects &  
XVW Architectuur



## Client

Consortium De  
Flat:KondorWessels Vastgoed,  
Hendriks CPO, Vireo Vastgoed,  
Hollands Licht/Martijn Blom

## Links

[www.nlarchitects.nl/slideshow/201](http://www.nlarchitects.nl/slideshow/201)

[xvwarchitectuur.nl/en/kleiburg-2](http://xvwarchitectuur.nl/en/kleiburg-2)

[www.archdaily.com/806243/deflat-nl-architects-plus-xvw-architectuur](http://www.archdaily.com/806243/deflat-nl-architects-plus-xvw-architectuur)

[www.e-architect.co.uk/amsterdam/kleiburg-apartments](http://www.e-architect.co.uk/amsterdam/kleiburg-apartments)

## Project details

**No. of dwellings:** 500

**Area:** Gross floor area 65,600 m<sup>2</sup>,  
net floor area 59,400 m<sup>2</sup>

**Mix:** Some apartments are combined  
to form a single unit, although  
most of them kept the original  
floor area

**Construction:** Revamp of existing building  
built in the '60s

**Year:** 2016

© Photo Stijn Poelstra





←  
Go to  
contents

### Description<sup>46</sup>

Kleiburg is one of the biggest apartment buildings in the Netherlands, with 500 apartments. It is 400 meters long, and 10 + 1 stories high.

DeFlat is an innovative renovation of one of the biggest apartment buildings in the Netherlands. Kleiburg is located in the Bijlmermeer, a CIAM inspired residential expansion of Amsterdam. Consortium DeFlat rescued the building from the wrecking ball by turning it into a "Klusflat", meaning that the inhabitants renovate their apartments by themselves.

A renewal operation started in the mid-nineties. The idea was to renovate the main structure – elevators, galleries and installations, but to leave the apartments unfinished and unfurnished: no kitchen, no shower, no

heating, no internal partitions. This would minimize the initial investments, and as such created a new business model for housing in the Netherlands.

The ambition was to open up new ways to live, to offer new typologies by combining two flats (or even more!) into one and by making vertical and horizontal connections.

The future residents could buy the shell for an extremely low price and then renovate it entirely according to their own wishes: DIY. Owning an ideal home suddenly came within reach.

### Note

- Innovative way of re-using an existing building through engaging future residents in creating their own affordable homes.

Original unit



Delivered unit

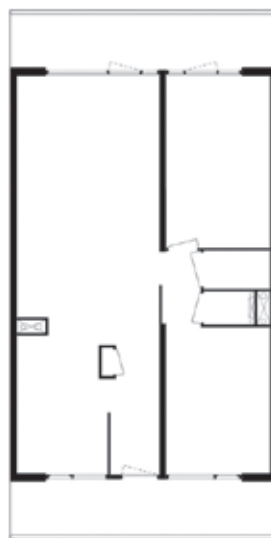

Unit renovated by new owner

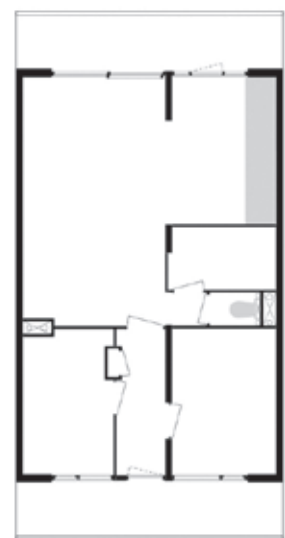

46 Edited version of description provided on architects' websites and in [archdaily.com](http://archdaily.com).





# Case study 37: Mix of houses and apartments, Arnhem



## Mix development with houses and apartments



### Location

Arnhem-Noord,  
the Netherlands



### Architect

Mecanoo



### Client

Proper-Stok Groep B.V.

### Link

[www.mecanoo.nl/Projects?project=113&t=3](http://www.mecanoo.nl/Projects?project=113&t=3)

### Description<sup>47</sup>

The Zwaluw Park housing project in Arnhem-Noord centres on the natural surroundings. The complex is located in a hilly area between Zwaluw Street and a thoroughfare, opposite the green Klarendal Park. Zwaluw Park comprises two residential blocks, both

47 Edited version of description provided on architect's website.

### Project details

**No. of dwellings:** 104

**Area:** 17,500 m<sup>2</sup>

**Mix:** 2 residential blocks with 36 single-family houses and 68 apartments (totalling 14,000 m<sup>2</sup>), a parking garage for 136 cars (3,500 m<sup>2</sup>), and public space

**Procurement:** Competition

**Car spaces:** 136

**Year:** 2016

© Photo Mecanoo



←  
Go to  
contents

organised around a spacious, child-friendly courtyard. The blocks vary in scale. The smaller accommodates 36 row houses while the larger contains 68 apartments. Dwellings vary in size and layout to suit different types of occupants. The raised blocks appear to hover above the ground. Surrounding the buildings, a dynamic landscape with different levels responds to the undulating terrain. In this way, entrances to the blocks are accessed from elevated walkways, and courtyards are slightly sunken.

This heightens the feeling of safety and experience of the green surroundings throughout the complex. A varied aesthetic is achieved by alternating the heights of the blocks, which do not exceed five storeys. Timber and glass are used extensively on the façades, lending the dwellings a modern, light, and transparent appearance. Large windows interrupt the horizontal lines of the balconies.

The shared gardens around the blocks are designed mostly as wild gardens that feature low-maintenance grasses, flowering plants, and native trees. There are no paths, so children can just play and wander around freely. An underground car park ensures that cars remain mostly out of sight.

#### Note

- **Mixture of housing and apartments in child-friendly housing, set in natural surroundings.**

# 7 / Denmark



Social, co-operative, and affordable housing in Denmark	157
Case study 38: Low income apartments, Dortheavej, Copenhagen	158
Case study 39: Saltholmsgade, social housing, Aarhus	162
Case study 40: Low income apartments, Fredriksberg	166
Case study 41: Sustainable and affordable dwellings, Hvalsø	167
Case study 42: Almenbolig+, standardised, affordable housing, Copenhagen	170
Case study 43: UN17 eco village, Copenhagen	173
Case study 44: The Iceberg, mixed development, Aarhus	177

# Social, co-operative, and affordable housing in Denmark

←  
Go to  
contents



**Population**  
5,806,000  
(2019)



**Dwellings**  
2,762,000



**Tenure<sup>48</sup>**  
Social rent: 19%  
Private rent: 30%  
Owner occupier: 51%



**Housing providers**  
Not for profit  
housing associations

Following a cholera outbreak in Denmark in 1853, doctors, scientists and politicians came together to improve living conditions of the workers of a newly industrialized nation. Since then, a robust partnership has emerged between the government and housing associations, drawing many architects and designers to participate in housing projects across Denmark.

The history of Danish residential architecture shows a keen interest in improving the quality of life through organization and naturalism. Following a global surge in rational modernism, urban planning and architecture followed a systemic approach to problem solving, with housing being no exception. Private-owner flats and collective housing applied this model to ensure each family and resident had enough space and to ensure that amenities were always close at hand.

The Danes also sought the positive health effects brought by nature and incorporated green areas and views of the natural landscape for residents.

After the 2007 global recession and the associated housing crisis, there was a sharp disinvestment by the government in housing. This resulted in the private, often overseas, investment and development of residential architecture. A result of this has been skyrocketing rent and an increase in social and ethnic segregation.

In Denmark today architects are facing these challenges and, as the following projects demonstrate, are seeking to create distinctive projects that address issues such as affordability, sustainability, and social cohesion.

## Points of special interest

- The focus on using prefabrication as a means of creating sustainable, affordable, high-quality housing.
- An emerging consideration of the need to consider all the UN sustainability goals – environmental, social, economic and cultural – using sustainable resources, and encouraging sustainable lifestyles.
- The potential for micro living at low rents to be linked to projects that support community cohesion.
- Danish architects are increasingly looking at ways of incorporating green infrastructure into their projects and of enhancing the existing biodiversity.
- Recent developments include low rental schemes with a sharing/community element.

## References

**Architizer:** [architizer.com/blog/inspiration/collections/danish-apartments](https://www.architizer.com/blog/inspiration/collections/danish-apartments) (accessed October 2020).

**Housing Europe:** [www.housingeurope.eu/resource-102/social-housing-in-europe](https://www.housingeurope.eu/resource-102/social-housing-in-europe) (accessed October 2020).

48 Karausevc, Paul and Batchelor, Abigail: Social Housing Definitions and Design Examples, RIBA Publishing (2017).

# Case study 38: Low income apartments, Dortheavej, Copenhagen



Mix development with houses and apartments



## Location

Dortheavej, Copenhagen,  
Denmark



## Architect

Bjarke Ingels Group (BIG)



## Client

Lejerbo

## Links

[big.dk/#projects-dong](http://big.dk/#projects-dong)

[www.archdaily.com/903495/homes-for-all-dortheavej-residence-bjarke-ingels-group](http://www.archdaily.com/903495/homes-for-all-dortheavej-residence-bjarke-ingels-group)

## Project details

<b>No. of dwellings:</b>	66 apartments
<b>Area:</b>	6,800 m <sup>2</sup> usable floor area. Each apartment unit ranges from 60 m <sup>2</sup> to 115 m <sup>2</sup> and has a 3.5m high floor to ceiling height in the kitchen and living spaces
<b>Procurement:</b>	Commission
<b>Construction:</b>	Timber clad, prefabricated structure
<b>Cost:</b>	€1,377 per sqm.
<b>Year:</b>	2018

© Photo Rasmus Hjortshøj







←  
Go to  
contents

### Description<sup>49</sup>

The 5-storey building winds through the area characterized by car repair shops, storage and industrial buildings from the 1930s–1950s. BIG was commissioned to design Dortheavej in 2013 by Danish non-profit affordable housing association Lejerbo, to create much needed affordable housing and public space in the area, while keeping the pedestrian passageways open and the adjacent green yard untouched.

BIG and Lejerbo received the Danish Association of Architects Lille Arne Award for prioritising the spatial qualities of the dwellings and the building strategy on a strict affordable housing budget.

“Our ambition was to create affordable apartments by the world’s leading architects. Together with BIG, we have succeeded in creating sustainable, safe and functional homes that see eye to eye with the people who live in them.” Jan Hyttel, President, Lejerbo Copenhagen.

“Affordable housing is an architectural challenge due to the necessary budget restrictions. We have attempted to mobilize modular construction with modest materials to create generous living spaces at the urban as well as the residential scale. The prefabricated elements are stacked in a way that allows every second module an extra metre of room height, making the kitchen-living areas unusually spacious. By gently adjusting the modules, the living areas open more towards the courtyard while curving the linear block away from the street to expand the sidewalk into a public square. Economical constraints often lead to scarcity – at Dortheavej, we have managed to create added value for the individual as well as the community.” Bjarke Ingels, Founding Partner, BIG.

The characteristic chequered pattern of Dortheavej is based on a singular prefab structure. Conceived as a porous wall, the building gently curves in the centre, creating space for a public plaza towards the street on the south side and an intimate green courtyard towards the north. On the street level, the building opens up to allow the residents and the general public to pass seamlessly into the courtyard.

The housing modules repeat along the curve and are stacked to the height of the surrounding buildings. The stacking creates additional space for each apartment to have a small terrace, providing a setting for healthy, sustainable living. On the sunny south side, balconies retract and add depth to the façade while on the northern side, the façade is even. Long wooden planks cover the façade on all sides, highlighting the modules and alternating to accentuate the chequered pattern.

Large floor-to-ceiling windows in the apartments allow lots of daylight into the units and outside views to the green courtyard or the surrounding neighbourhood. The materials are all kept very simple with wood and concrete in light colours dominating inside and out.

The small square created by the building’s slight curve will be landscaped with cherry trees and spaces for bicycle parking—the preferred way of getting around the city.

The north facing façade looks towards an enclosed green courtyard which residents of Dortheavej and the neighbouring buildings can use for recreational activities.

### Note

- **The prefabricated structure prioritises the spatial qualities for the residents, while being on a strict affordable housing budget.**

49 Edited version of description provided on architect’s website and description in [archdaily.com](https://www.archdaily.com).

© Photo Rasmus Hjortshøj

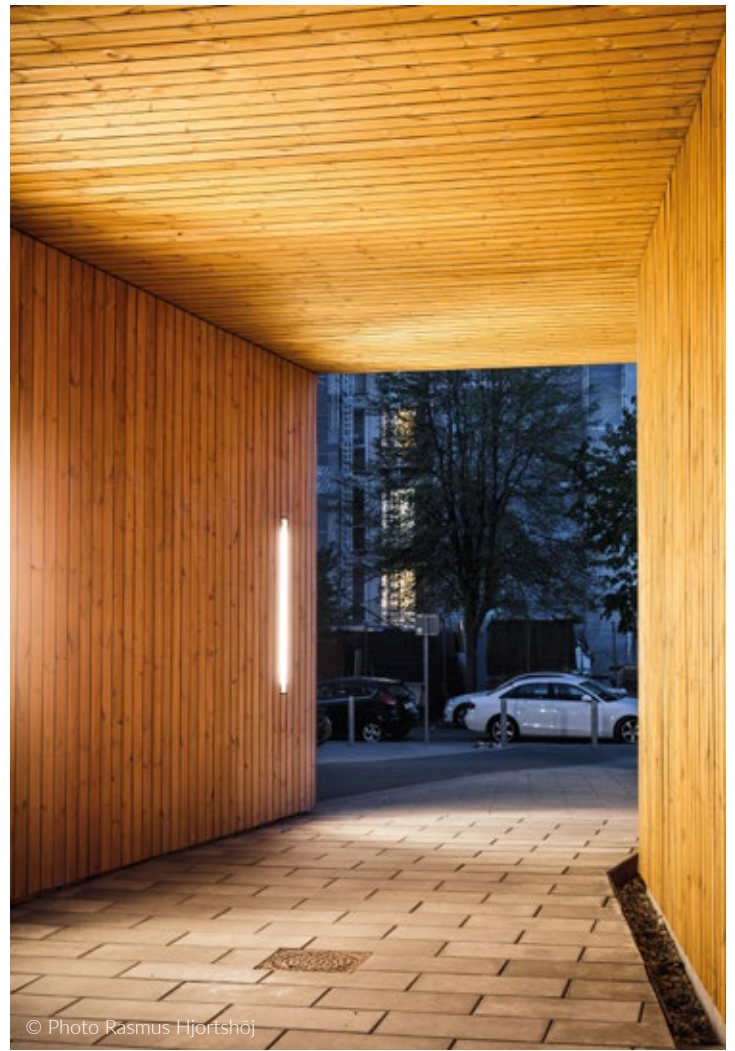

© Photo Rasmus Hjortshøj

© Photo Rasmus Hjortshøj



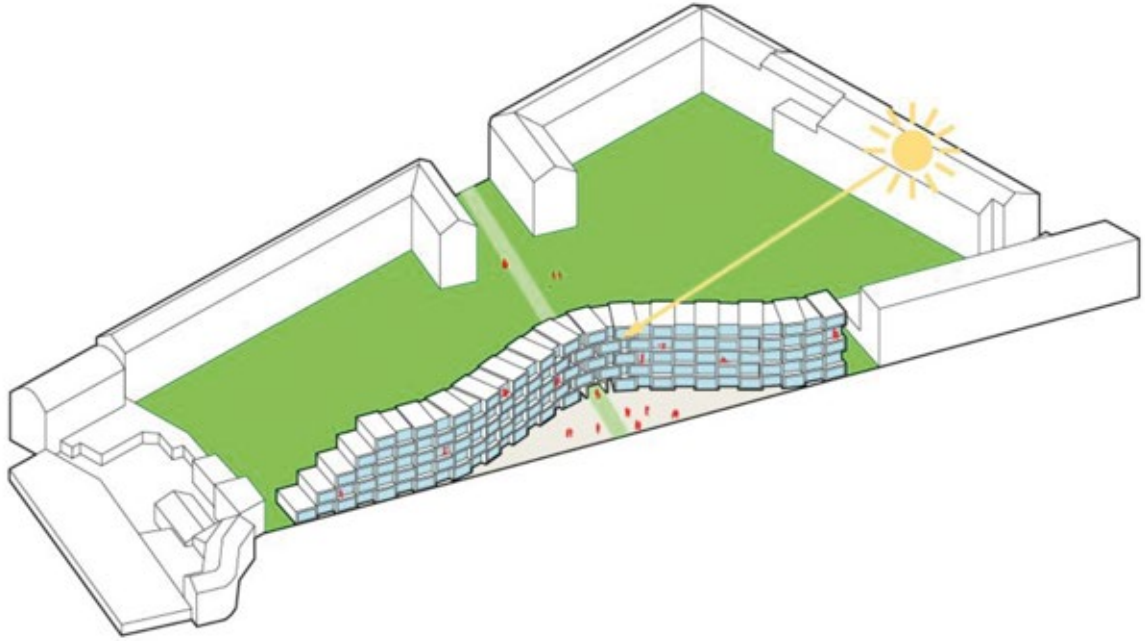

**SOCIAL REALM**

THE SYSTEM COMBINES A VALUABLE PUBLIC SPACE WITH SOCIAL HOUSING UNITS OPTIMALLY ORIENTED.

© BIG

# Case study 39: Saltholmsgade, social housing, Aarhus



## Social housing



### Location

Aarhus, Denmark



### Architects

WE Arkitekten, in collaboration  
with JWH Arkitekter



### Client

Boligforening Ringgarden

### Links

[www.we-a.dk/saltholmsgade-1](http://www.we-a.dk/saltholmsgade-1)

[www.archdaily.com/805752/we-architectures-winning-proposal-combines-green-space-with-social-housing-in-aarhus](http://www.archdaily.com/805752/we-architectures-winning-proposal-combines-green-space-with-social-housing-in-aarhus)

[divisare.com/projects/339076-we-architecture-we-architecture-jwh-arkitekter-combines-green-space-with-social-housing](http://divisare.com/projects/339076-we-architecture-we-architecture-jwh-arkitekter-combines-green-space-with-social-housing)

### Project details

No. of dwellings:	38
Area:	3,500 m <sup>2</sup>
Procurement:	Competition
Energy performance:	Emphasis on green infrastructure
Year:	2016-ongoing

© Photo WE Architectur



←  
Go to  
contents

### Description<sup>50</sup>

The project interprets the traditional historical city houses along Hjortensgade as modern, social and green communities. Communal features are places on the roof-garden from where residents can have an overview of Aarhus. It seeks to restore the lost green space from the footprint of the building by placing a roof park on the top of the settlement.

At the same time, the project interprets the traditional varied roof profile of the historical city houses as modern, social, and green communities. This is incorporated into the roof park by including small squares, gardens, and greenhouses, from which residents can gather around vegetable gardens, playgrounds and enjoy an overview of Aarhus. The rooftop will create communal activities and a social venue for residents to come together.

In order to create small, semi-public meeting spaces in front of the building, the volumes are pushed back alternatively. Subdividing the building makes it possible to add vegetation to the existing streetscape. The building stands as a gateway to the city and defines the transition from the inner city to the green areas of the botanical garden.

### Note

- **Combines social housing with green infrastructure. Floor plans allow for a variety of living arrangements.**

---

50 Edited version of description provided on architects' websites and description in Divisare and [archdaily.com](https://www.archdaily.com).



←  
Go to  
contents



© WE Architecture in collaboration with JWH Arkitekter

### 1.

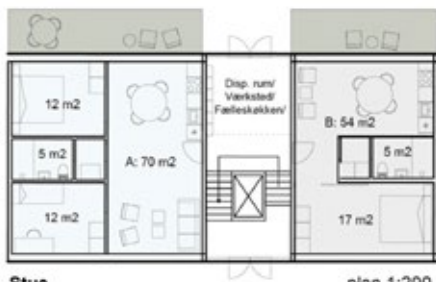

**Stue**  
Lejlighed A (et plan):  
køkken al og stue, 2 vær, 70 m<sup>2</sup>, have 15 m<sup>2</sup>  
Lejlighed B (et plan):  
køkken al, stue/vær, 54m<sup>2</sup>, have 10 m<sup>2</sup>

### Alt 1.



**1.sal**  
Lejlighed A (et plan):  
køkken al og stue, 2 vær, 70 m<sup>2</sup>, altan 5 m<sup>2</sup>  
Lejlighed B (et plan):  
køkken al, stue, 1 vær, 64m<sup>2</sup>, altan 5 m<sup>2</sup>

© WE Architecture in collaboration with JWH Arkitekter



**Alt. 2.**



**1.sal** plan 1:200

Lejlighed A (et plan):  
køkken al og stue, 3 vær, 80 m<sup>2</sup>, altan 5 m<sup>2</sup>  
Lejlighed B (et plan):  
køkken al, stue/værelse, 54m<sup>2</sup>, altan 5 m<sup>2</sup>

**Alt. 4.**



**1.etage**

Lejlighed A (et plan):  
køkken al og stue, 2 vær, 70 m<sup>2</sup>, altan 5 m<sup>2</sup>  
Lejlighed B (duplex):  
køkken al, stue og 3-4 vær, 120m<sup>2</sup>, 2 altaner a 5 m<sup>2</sup>

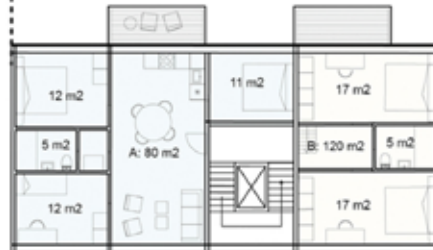

**2. etage**

Lejlighed A (et plan):  
køkken al og stue 3 vær, 80 m<sup>2</sup>, altan 5 m<sup>2</sup>  
Lejlighed B (duplex):  
køkken al, stue og 3-4 vær, 120m<sup>2</sup>, 2 altaner a 5 m<sup>2</sup>



General plan 1:500



stueplan 1:500

# Case study 40: Low income apartments, Fredriksberg



## Venligbolig plus (friendly housing plus)



### Location

Fredriksberg, a Danish municipality close to Copenhagen



### Architect

ONV Arkitekter

### Description<sup>51</sup>

Venligbolig started out as an activist idea, to invite refugees into the everyday life of the city and make it easier for cities, citizens, and housing organizations to invite all citizens on the edge of society into the community.

Venligbolig consists of compact housing, where students and refugees can live for 2,500 kroner (€335.00) (1500-2000 kr under market price) in the middle of the city and be part of the local community. The aim of the project is to support integration, friendship, and democratic development. Danish students are buddies to refugees and help them in the day-to-day living.

In 2019 74 young students and refugees moved into the newly established Venligbolig Plus. This was made possible thanks to the collaboration with the Municipality of Frederiksberg and Frederiksberg United Housing Companies (Forenede Boligselskaber).

Venligbolig Plus in Fredriksberg consists of three blocks, which house in total 37 apartments (33 m<sup>2</sup> each). Here two people live together in a shared apartment where each resident has their own private room and the kitchen and toilet are shared with the other person in the apartment. Connected to the apartments in the three different blocks is a communal room and laundry room and a communal rooftop on the upper floor. Light, simple and modular, Venligbolig Plus is designed to be moved, relocated, and re-assembled into new housing solutions

### Note

- An example of small, pre-fabricated apartments with an emphasis on integration and low rental.
- Provides buddy system between students and refugees.

### Links

[onv.dk/wp-content/uploads/2019/12/Berlingske-Tidende-artikel-Venligbolig-plus-ONV-arkitekter.pdf](https://onv.dk/wp-content/uploads/2019/12/Berlingske-Tidende-artikel-Venligbolig-plus-ONV-arkitekter.pdf)

[www.wedodemocracy.dk/venligbolig-plus-1](http://www.wedodemocracy.dk/venligbolig-plus-1)

### Project details

<b>No. of dwellings:</b>	37
<b>Area:</b>	33 m <sup>2</sup> each
<b>Mix:</b>	All two bedroom apartments (with 2 people sharing)
<b>Construction:</b>	Pre-fabricated, space-sized modules with load-bearing wooden structures
<b>Energy performance:</b>	Less material waste through pre-fabrication
<b>Year:</b>	2019



© ONV Arkitekter

<sup>51</sup> Edited version of description provided on architect's website and in [wedodemocracy.dk](http://wedodemocracy.dk).



# Case study 41: Sustainable and affordable dwellings, Hvalsø

←  
Go to  
contents

## Affordable housing



### Location

Hvalsø, Denmark



### Architect

Sigurd Larsen

### Links

[sigurdlarsen.com/project/frikobing\\_dk](http://sigurdlarsen.com/project/frikobing_dk)

[www.dezeen.com/2017/05/26/sigurd-larsen-affordable-sustainable-larch-cladding-light-green-eco-house-frikobing-denmark](http://www.dezeen.com/2017/05/26/sigurd-larsen-affordable-sustainable-larch-cladding-light-green-eco-house-frikobing-denmark)

### Description<sup>52</sup>

Berlin-based architect Sigurd Larsen designed these two larch-clad homes as a sustainable and affordable model for an “organic” housing development. The

<sup>52</sup> Edited version of description provided on architect's website and in [dezeen.com](http://dezeen.com).

homes consist of a simple plan arrangement that allow for low construction costs while offering generous living spaces.

The homes were created for a sustainable housing development called Frikøbing, which is located around 60 kilometres inland from Copenhagen.

The affordable typologies, which cost approximately 15,000 DKK (£1,745) per square metre, are named The Green House and The Light House. The houses have slight variations but are both designed to make use of passive cooling and heating in a bid to reduce energy consumption in line with Frikøbing's principles.

### Project details

**No. of dwellings:** 2 (more planned)

**Area:** 82 sqm, with a 32 sqm winter garden and 135 sqm

**Mix:** All two bedroom apartments (with 2 people sharing)

**Energy performance:** Passive heating and cooling

**Year:** 2017

© Photo Sigurd Larsen





The Green House is 82 square metres, with a 32-square-metre winter garden, and comes in at just under £200,000, while The Light House is a mono-pitched design with a plan of 135 square metres, making it £235,500.

“All future house designs in the area will be uniquely designed for individual families and their needs and budgets,” Sigurd Larsen told Dezeen. “But all houses follow the same zoning plan for the area with high requirements of sustainability.”

“The development plan for the area has high demands on sustainability for construction materials, insulation, energy and air circulation,” added Larsen.

**Note**

- A simple, affordable design that can be modified to suit the needs of different occupiers.



© Sigurd Larsen

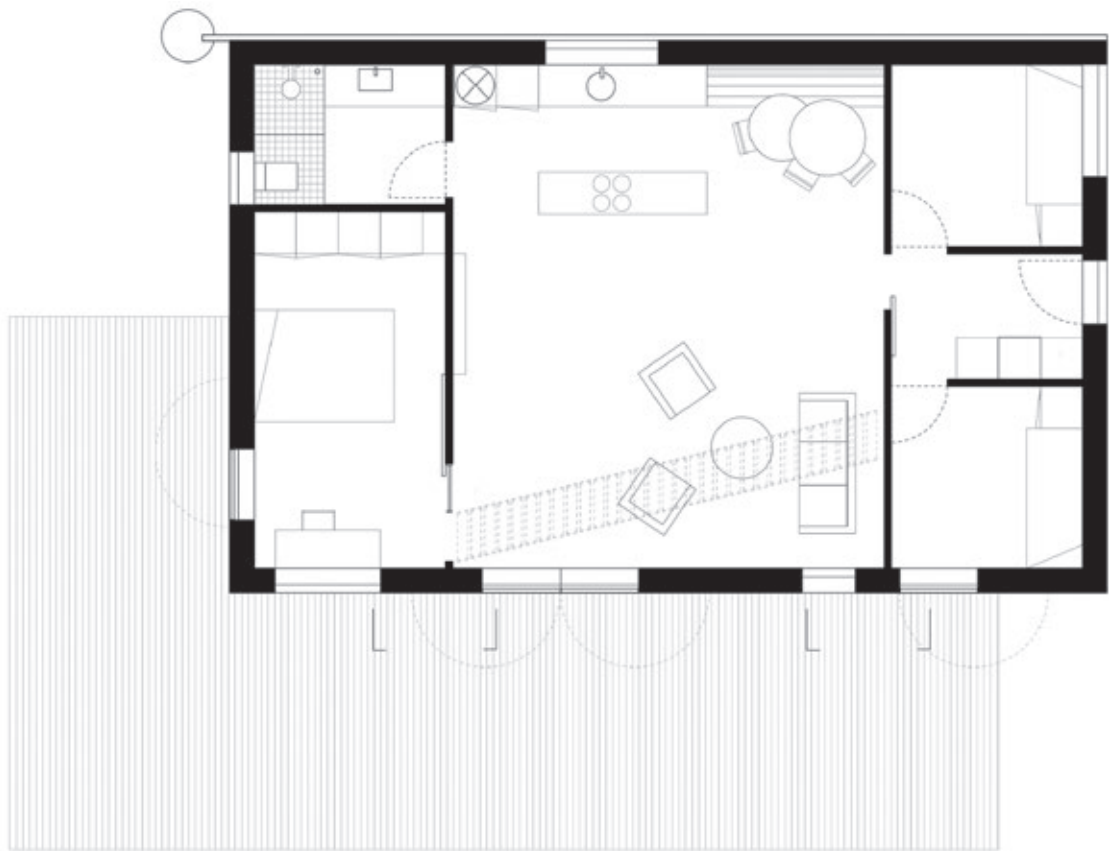

© Sigurd Larsen



© Photo Sigurd Larsen

# Case study 42: Almenbolig+, standardised, affordable housing, Copenhagen



## Affordable housing



### Location

Eight different sites in and around Copenhagen



### Architects

JAJA Architects, ONV Arkitekter, Bascon & Scandi By



### Clients

KAB & 3B

### Links

[www.ja-ja.dk/project/almenbolig](http://www.ja-ja.dk/project/almenbolig)

[onv.dk](http://onv.dk)

[www.archdaily.com/392609/almenbolig-affordable-housing-winning-proposal-jaja-onv](http://www.archdaily.com/392609/almenbolig-affordable-housing-winning-proposal-jaja-onv)

### Project details

**No. of dwellings:** 400 plus

**Area:** 80-100 sqm

**Mix:** Pre-fabricated system that can accommodate a variety of sizes and housing types

**Procurement:** Competition

**Construction:** Pre-fabricated timber module

**Year:** 2014 – ongoing

© Photo JAJA Architects, ONV Arkitekter

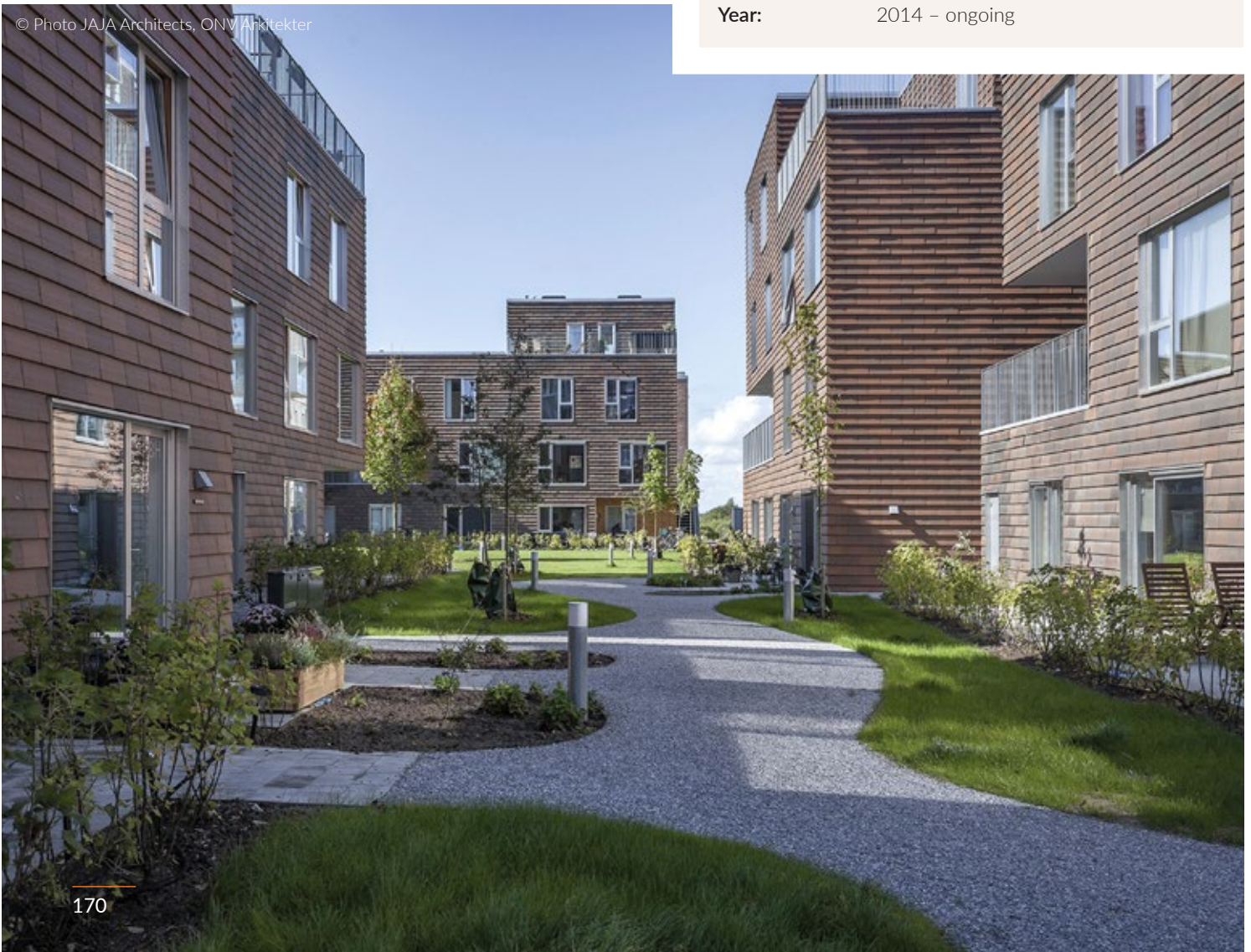

←  
Go to  
contents

### Description<sup>51</sup>

Almenbolig+ is an affordable housing concept. This is the 4th stage of delivery of the affordable housing concept AlmenBolig+.

Based on a 'standardized variation', it is an efficient prefabricated system designed to be economical and production friendly while allowing great flexibility in design possibilities.

Like large-scale building blocks, the prefab system can be used to form four-storey point houses, row houses or even conventional single-family houses. It can be used to create single apartments to large family apartments. The flexibility of the building blocks also allow differentiation that interacts with the landscape to create attractive and varied outdoor spaces – e.g. individual spaces for private gardens and larger common spaces.

In 2018, more than 400 housing units on more than eight sites have been completed in the greater Copenhagen area based on the Almenbolig+ concept. The possibilities it allows have resulted in various designs in Arenakvarteret in Ørestad, Albertslund, Ishøj, Jyllinge and Herlev.



© Photo JAJA Architects, ONV Arkitekter

### The system

The base modules can be organized in numerous variations. From detached low-density housing to rowhouses and four-story point houses, they can form different apartment layouts and various building typologies.

### Standard variations

Like large-scale building blocks, the system can form different apartment sizes and types, which altogether provide the possibility of creating housing developments with broad demographic compositions.

### Four stories

In Nordrefælled Kvarteret in Ørestad Almenbolig+ was used to form four-story housing to achieve a certain density.

### Houses in the green

In Jyllinge, the housing was completed adjacent to a green recreational area. Here Almenbolig+ was two stories with a large roof that slopes down in relation to the surrounding landscape.

### Row houses

On Robinievej in Albertslund, the Almenbolig+ consists of two-story rowhouses that form common green recreational spaces.

### Interior organisation

All the homes are organized around a central core and a staircase, which partly allows natural divisions, and the possibility of daylight from above in the middle of the home.

### Note

- This is a high quality pre-fabricated system that can deliver a wide variety of housing typologies, including higher density solutions.

53 Edited version of description provided on architect's website and in [archdaily.com](https://www.archdaily.com).

←  
Go to  
contents

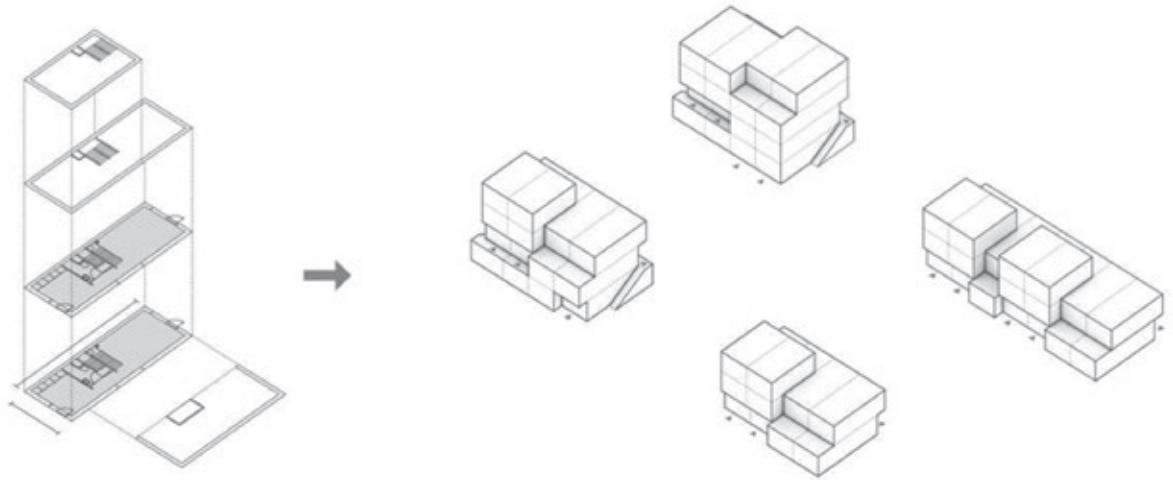

© JAJA Architects, ONV Arkitekter

© Photo JAJA Architects, ONV Arkitekter



# Case study 43: UN17 eco village, Copenhagen



## Eco-village



### Location

Copenhagen



### Architects

Lendager Group &  
Årstiderne Arkitekter



### Clients

NREP

### Links

[lendager.com/en](http://lendager.com/en)

[aarstiderne.dk/en/cases/un17-village](http://aarstiderne.dk/en/cases/un17-village)

[www.dezeen.com/2018/12/10/un17-village-eco-housing-copenhagen-lendager-group-arstiderne-arkitekter](http://www.dezeen.com/2018/12/10/un17-village-eco-housing-copenhagen-lendager-group-arstiderne-arkitekter)

[www.archdaily.com/907097/sustainable-startup-beats-out-big-henning-larsen-for-a-new-eco-village-in-copenhagen](http://www.archdaily.com/907097/sustainable-startup-beats-out-big-henning-larsen-for-a-new-eco-village-in-copenhagen)

### Project details

**No. of dwellings:** 500 apartments in 5 buildings

**Area:** 35,000 sqm

**Mix:** Family dwellings, co-living spaces, student and senior accommodation and communal areas

**Procurement:** Development competition

**Energy performance:** The structures will rely solely on sustainable energy

**Year:** Scheduled to be completed in 2023

© Visualisations TMR





### Description<sup>54</sup>

A 35,000-square-metre eco-village is planned for Copenhagen using recycled concrete, wood and glass.

Architecture studios Lendager Group and Årstiderne Arkitekter won a competition to design the UN17 Village, a housing development set to provide 500 new homes in Ørestad South, a district to the south of the Danish capital.

Their proposal is to create "the first building project in the world" to address all of the UN's Sustainable Development Goals (SDGs), with particular focus on using sustainable resources and creating healthy, social communities.

"With the UN17 Village, we wanted to create not only an iconic and sustainable building from recycled materials, but also the opportunity for a sustainable lifestyle," said Anders Lendager, founder of Lendager Group.

"So far, the focus for sustainable buildings has mainly been on their carbon emissions," he explained. "Not only did we want to create an iconic building made from recycled materials, but also an opportunity for a sustainable lifestyle".

The proposal comprises five housing blocks built from recycled concrete and wood, as well as upcycled windows.

The structures will rely solely on sustainable energy. Each will be topped with a rooftop garden, to encourage biodiversity, and will also feature rainwater collection facilities capable of recycling 1.5 million litres of water every year.

There will be 37 different housing typologies, with a mix of family dwellings, co-living spaces and senior accommodation. They will create homes for up to 800 people, as well as an estimated 100 job opportunities.

To further this, 3,000 square-metres of the complex is dedicated to communal spaces for use by both the residents and the people of Ørestad.

Lendager said the aim is to reduce inequality, by creating "a diverse and strong neighbourhood, where people can live regardless of family structure and age".

Other facilities will include a dining house (vegetarian and organic food), communal house (for everyday use and parties), health house (fitness, team training, swimming), health clinic with a village doctor, lobby with library and workplaces, and a sharing/resource centre with a workshop.

The architects hope the scheme will set a precedent for the rest of the world, forming a sustainable building model that can be applied at any scale. According to Lendager, the project will address all 17 of the UN's SDGs.

"We have developed a scalable process that brings all the SDGs into focus. By translating these into solutions, we have created a tool that everyone in the industry can implement," he added.

The Ørestad South district of Copenhagen has been in development for the past 25 years. Other well-known projects in the areas include the award-winning 8 House by BIG and Street Hall Ørestad, a wooden sports centre by NORD Architects.

### Note

- **Pioneering sustainable development that aims to address all of the UN's Sustainable Development Goals and support sustainable lifestyles – percentage of social/affordable dwellings unknown.**

---

<sup>54</sup> Text based on description provided by the architects and by Eric Baldwin, editor of archdaily.





© Visualisations TMRW





© Visualisations TMRW

# Case study 44: The Iceberg, mixed development, Aarhus

←  
Go to  
contents

## Mixed development



### Location

Aarhus, Denmark



### Architects

JDS Architects, SeArch,  
Cebra & Louis Paillard  
Architects

### Links

[jdsa.eu/tad](http://jdsa.eu/tad)

[www.se-arch.com](http://www.se-arch.com)

[cebraarchitecture.dk/project/the-iceberg](http://cebraarchitecture.dk/project/the-iceberg)

[www.louispaillard.com/projets-63](http://www.louispaillard.com/projets-63)

[www.archdaily.com/483415/the-iceberg-cebra-jds-search-louis-paillard-architects](http://www.archdaily.com/483415/the-iceberg-cebra-jds-search-louis-paillard-architects)

### Description<sup>55</sup>

The Iceberg is located at a prime location on the outmost harbour front in Aarhus' new quarter Aarhus Ø (Aarhus East) and consists of 208 apartments. The Iceberg will contribute to transforming the former container port of Aarhus into a vibrant new neighbourhood that on completion will be home to 7,000 inhabitants and provide 12,000 workplaces.

The Iceberg is laid out as four L-shaped wings, where the street spaces in between open towards the water. In order to obtain optimal daylight conditions and views over the bay for as many apartments as possible,

<sup>55</sup> Edited version of description provided on architects' websites and in [archdaily.com](http://archdaily.com).

### Project details

<b>No. of dwellings:</b>	208
<b>Area:</b>	22,000 sqm
<b>Procurement:</b>	Invited competition
<b>Car spaces:</b>	Car parking is kept to the outer perimeter with some informal car-sharing between friends
<b>Year:</b>	2013

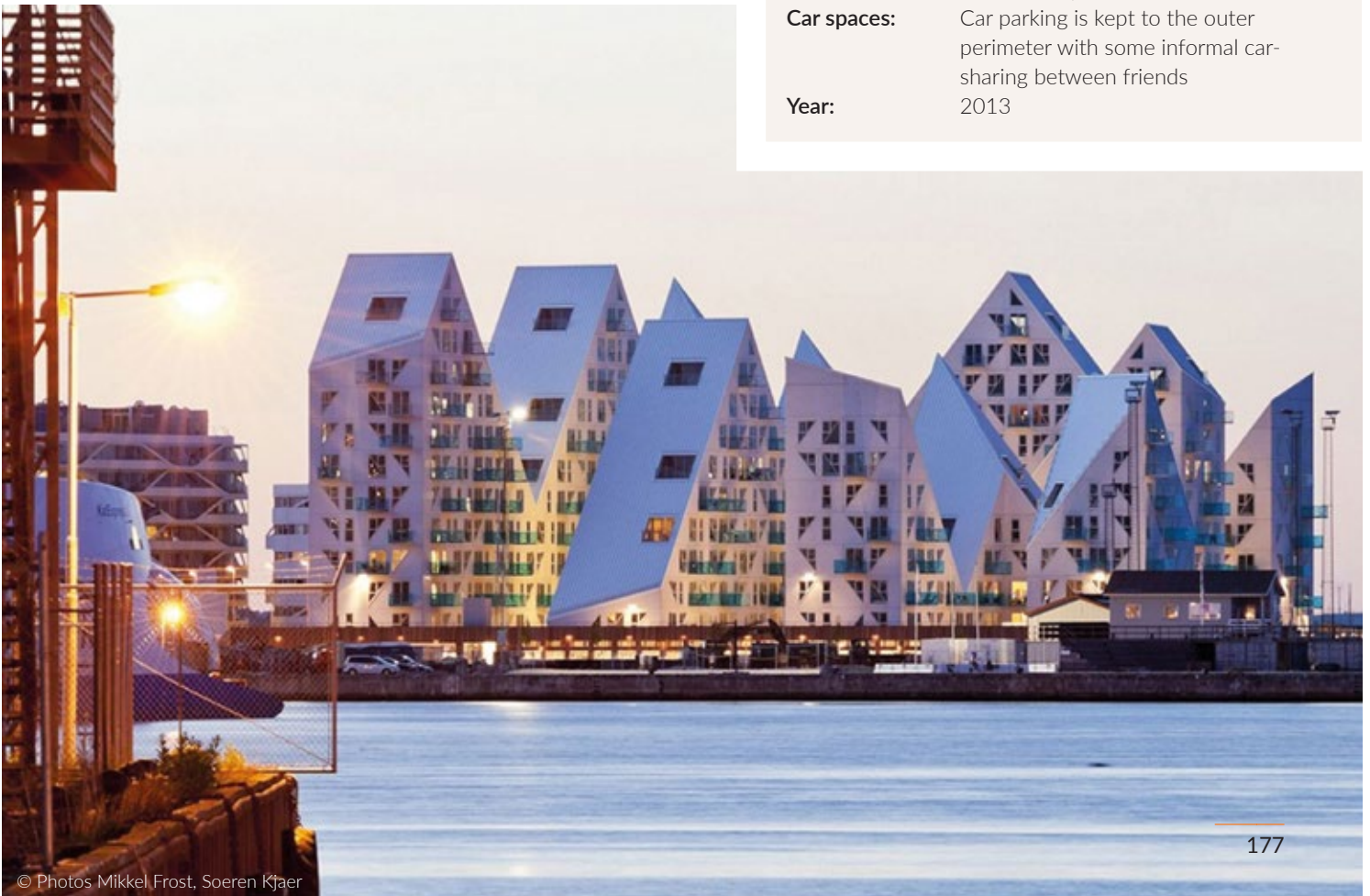



the building volume is cut up by jagged lines. The roofs rise and fall into peaks and valleys, which create visual passages that allow views across the individual volumes – like floating icebergs that constantly refract one's gaze. Thus, even the apartments in the back wing can enjoy the view. By applying this simple algorithm to the design, the spectacular iceberg structure emerged.

The varying building volumes make it possible to arrange a wide range of different apartment types within the complex – from two-storey 'town houses' and affordable smaller apartments to exclusive penthouses in the peaks of the Iceberg. The variety of residences with different balconies, shapes and

orientations as well as the combination of owner-occupied and rented flats aim at creating socially diverse urban surroundings that form a lively local community. The building complex becomes a neighbourhood instead of a mere series of housing blocks.

A third of the Iceberg's 200 apartments are designated as affordable rental housing, aimed at integrating a diverse social profile into the new neighbourhood development.

**Note**

- Affordable rental included in a mixed tenure housing scheme.

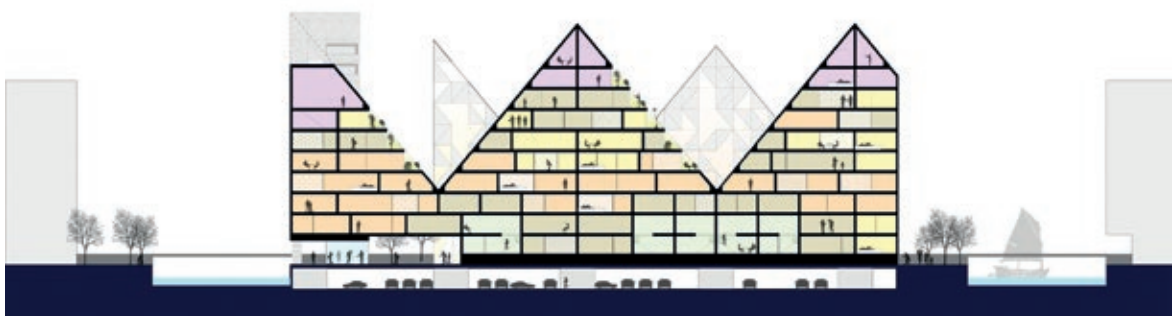

© JDS Architects, SeArch, Cebra, Louis Paillard Architects

© Photos Mikkel Frost, Soeren Kjaer

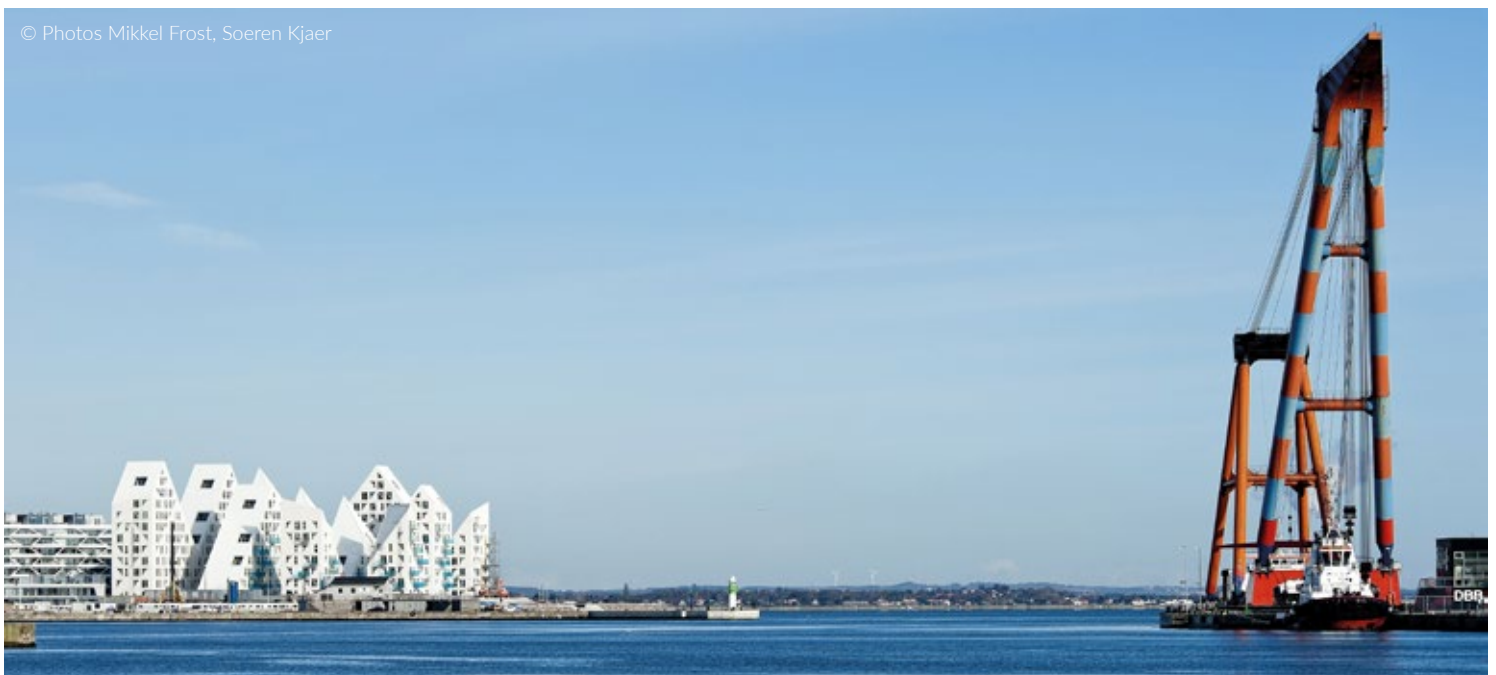



←  
Go to  
contents

Floor plans



© JDS Architects, SeArch, Cebra, Louis Paillard Architects



© JDS Architects, SeArch, Cebra, Louis Paillard Architects





**An Ghníomhaireacht  
Tithíochta**  
The Housing Agency

**The Housing Agency**  
53 Mount Street Upper  
Dublin, D02 KT73

 (01) 656 4100

 [info@housingagency.ie](mailto:info@housingagency.ie)

 [housingagency.ie](http://housingagency.ie)